



Norwegian University
of Life Sciences

Master's Thesis 2018 30 ECTS

Faculty of Environmental Sciences and Natural Resource Management

Application of Aerogel - based plaster for refurbishment and preservation of a listed historic masonry building in Norway – an in- situ energy efficiency study

Cato Solheim
Renewable Energy

Preface

This thesis concludes my Master thesis in Renewable Energy and six years of higher education in total.

I would wholeheartedly want to thank my thesis advisor, Thomas Martinsen for great consultation, and the patience to guide me through this rollercoaster. Thanks to Erlend Kolding at Boligbygg who assisted me without question. And las but not least, I want to thank my lovely fiancée and my little son for enduring the last few months of fast paced action.

Ås, 15. Jun 2018

Cato Solheim

Abstract

This thesis examines the energy efficiency effects of refurbishing historic masonry buildings in a Norwegian climate with the use of an aerogel-based plaster (FIXIT222) for cold side insulation. Additionally, it aims to find how well the manufacturer's performance graph of FIXIT222 applies to brick buildings in a Norwegian climate.

The Norwegian government has proclaimed that it aims to make way for energy efficiency in the existing building mass as a means toward a "greener" future. In the capitol of Oslo, the existing building mass consists largely of late 1800's masonry buildings. Because of the old age, these buildings are poorly insulated, which leads to significant heat loss, inadequate energy efficiency and often, unhealthy indoor climate. They need refurbishing.

Refurbishing of existing building regulates by the national Regulations on technical requirements for building works (TEK17). The net energy demand requirement for TEK17 is very difficult to achieve in such buildings without extensive insulation on the warm side of the envelope. This is bad for the building bricks, as the temperature outside the insulation drops and may lead to storage of moisture, which in turn will freeze and the bricks crackle. It also reduces the living area indoors (BRA).

The alternative is cold side insulation. However, most of these buildings have historic value and are listed in the Cultural heritage management office's "yellow list", meaning that any substantial changes to the façade or original structure is prohibited.

Fixit222 is a super insulating Aerogel-based plaster that can be sprayed on the building façades without substantially altering the architectural expression and thus, the historical value. The Cultural heritage management office has given Boligbygg Oslo KF permission to refurbish an 1890's brick building in this way.

Analyses of the effect is found by field study data collection and model studies with the building energy simulation software SIMIEN.

The model studies show a total decrease in net energy demand by 65%. When pinpointing the effect of FIXIT222, it represents 38% of the total decrease in net energy demand.

Temperature and relative humidity measured inside the wall remain well balanced throughout varying indoor and outdoor conditions.

In comparison with the measured energy consumption, the model estimates overshoot reality by 30%. This difference may be explained by the need to extrapolate the consumption data.

Based on the results found, it can be concluded that the effect of FIXIT222 in Norwegian climate is of the same magnitude as the result of the pilot project “Mühle Sissach”. It can also be concluded that the manufacturer performance graph is directly applicable to late 1800’s masonry buildings in Norwegian climate.

List of tables and figures

Figure 1- Diagram from the manufacturer, showing the correlation between applied thickness and U-value.....	14
Figure 2- The methodical approach used to calculate U-value, according to ISO standard 6946:2014.	17
Figure 3- Figure describing the methodical approach of calculating U-value with Wufi.....	19
Figure 4- Screenshot showing input for material thickness and properties input in Wufi.....	19
Figure 4- Figure describing the methodical approach to determining U-value through measurements.	20
Figure 5- Principle of heat flux measurements through the envelope as seen from above.	21
Figure 6 – A screenshot of the data imported to Microsoft Excel.....	21
Figure 7- The methodical approach to measuring and formatting weather and indoor climate data.	23
Figure 8- Figure describing the methodical approach to acquiring new energy data using the Power tag sensors.	23
Figure 9- Example of Acti 9 Smartlink system setup connected to the local grid.	24
Figure 10- The approach of the model studies in the thesis.	26
Figure 11- Classification of deviancy in simulations, according to NS-EN15265:2007.	27
Figure 12- The thesis' approach to comparing the U-values.....	28
Figure 13- To determine the effect of the energy consumption, the old and the new energy data are compared.....	28
Figure 14- Methodical approach to comparing model results	29
Figure 15- Overview photo of Oslo, indicating the position of Bergsliens Gate 12B-C in relationship to the Royal Palace.....	30
The image is made using the online map service Norgeskart.	31
Figure 16- Bird perspective of Bergsliens Gate 12B-C shows the placement within the quarter.	31
The image is made using the online map service Norgeskart.	31
Figure 17- Three-dimensional representation of BG12BC viewed from south. The image is collected from Google Earth.....	32
Figure 18: The northeast façade of BG12B-C after refurbishing. Photo: Eivind Røhne/FutureBuilt. ...	32
Figure 19: Architectural drawing of the building anno 1887 (Source: Boligbygg).....	33
Figure 20: Sketch from 1988 shows the transformation to apartments (Source: Boligbygg).	34
Table 1- List of thermal conductivity requirements from Tek87 and values for BG12BC that are either calculated or assumed based on similar structural composition.	35
Figure 21 - Picture showing a window cavity after cleaning, before application of FIXIT (source: Boligbygg).....	37
Figure 22- Image one: The clean surface, ready for application of the undercoat layer. Second image: The surface with an undercoat layer. When the undercoat is dry, a layer of Fixit222 can be applied (Source: Boligbygg).	38
Figure 23- A worker applying Fixit222 with a spray gun ((Source: Boligbygg).....	38
Figure 24- Cross section sketch of the envelope with added Fixit222.	39
Figure 25-Blueprint of the Northeast façade of Bergsliens Gate 12B-C. (Source: Boligbygg).	40
Figure 26- Blueprint drawing of the ground floor plan. (Source: Boligbygg).....	40
Figure 27- Blueprint drawing of the 1st floor plan (Source: Boligbygg).	41
Table 2- Technical cross section material data prior to refurbishment.....	41
Table 3- Technical cross section material data after refurbishment.....	42

Figure 28- Difference between calculated U-value in original structure and retrofitted structure.	42
Figure 29- Using the FLIR I3 thermal imaging camera.	43
Figure 30- Thermal image of the first floor, between windows.	44
Figure 31- Red arrows indicating the position of the flux sensors.	44
Figure 32- Hukseflux TRSY01 datalogger	
Figure 33- Heat flux sensor and temperature sensor (warm side).....	45
Figure 34- The red arrows indicates the sensor placement inside apartment and inside the wall.	47
Figure 35- Two Elprolog logger units mounted under the cornice.	48
Figure 36- Local measurements compared to data from met.no shows the approximate accuracy of the temperature reading.	49
Table 4- U-value of the envelope cross before and after refurbishing, and the resulting reduction percentage.	52
Table 5- U- value of the envelope cross section as simulated in Wufi U.	52
Figure 37 - Graph showing the varying U-vale calculated from the measured heat flux and delta T. .	53
Figure 38- Temperature and relative humidity measurements from outside Bergsliens Gate 12B-C. .	53
Figure 39 - Indoor temperature and relative humidity measurements (ground floor).....	54
Figure 40- Temperature and humidity measurements, ground floor apartment.	54
Figure 41- Temperature and relative humidity measurements from inside the envelope.	55
Table 6- Specific energy demand from three different methods of extrapolation	55
Table 7- Energy consumption before the refurbishment. 1st floor is estimated.	56
Table 8- Energy budget of Bergsliens Gate 12B-C prior to refurbishment.	56
Table 9- Energy budget of Bergsliens Gate 12B-C after refurbishment.	57
Table 10- Energy budget of Bergsliens Gate 12B-C after refurbishment (floor changed).....	57
Table 11- Specific energy demand for model 1 and 2.	58
Figure 42- Comparison of heat loss coefficient before and after refurbishment.....	58
Table 12- Reduction in kWh for each specific variable from model 1 (prior) to model 3 (best case after)	59
Figure 43- Predicted annual energy consumption, to simulated annual energy consumption.	60
Figure 44 - Graph depicting U-values of original structure, measured new value and u-value of Fixit and mineral wool in relation to thickness applied.....	61
Figure 45- Manufacturers performance graph for FIXIT222.....	62

Table of Contents

Abstract.....	2
List of tables and figures	4
1. Introduction	9
1.1 Central terms	11
2. Background and theory.....	12
2.1 Fixit222 Aerogel Plaster	13
2.2 FutureBuilt and Bergsliens gate.....	15
3. Methods and Equipment	16
3.1 Literature and field studies	16
3.1.1 Calculating u-value.....	16
3.1.2 Calculating transient u-value and moisture content with Wufi Pro	18
3.1.3 Measuring U-value	19
3.1.4 Measuring weather data.....	22
3.1.5 Measuring energy consumption after rehabilitation.	23
3.2 Model studies with SIMIEN	25
3.5.1 Data collection and formatting	27
3.5.2 Validation and reliability	27
3.6 Comparison	28
3.6.1 Comparing U-values.....	28
3.6.2 Comparing measured energy consumption to old energy consumption	28
3.6.3 Comparing Simulated energy consumption to Measured energy consumption.....	29
4. Case Study Bergsliens Gate 12B-C	30
4.1 The building.....	30
4.1 Construction history.....	33
4.3 Original construction and technical data.....	35
4.2 Refurbishing scope.....	36
4.3 Application of FIXIT222	37
4.3 Construction and technical data after refurbishment	39
4.3 Literature and field studies	41
4.3.1 manual calculation of U-value	41
4.3.3 Calculating U-value with Wufi.....	42
4.3.3 Measuring U-value	43
4.3.4 Measuring weather data.....	46

4.3.5 Measured Energy consumption	50
4.3.6 Past Energy consumption	50
4.5 SIMIEN Model Studies of Bergsliens Gate 12B-C	51
5.Results	52
5.1 Literature and field studies	52
5.1.1 Manually calculated U-value.....	52
5.1.2 U-value as simulated by WUFI U.....	52
5.1.3 Measured U-value.....	52
5.1.4 Measured weather and climate data.....	53
5.2.4 Measured energy consumption	55
5.2.5 Previous energy consumption.....	56
5.2 Model studies	56
5.2.1 Model 1 – prior to the refurbishment.....	56
5.2.2 Model 2 – after refurbishment	57
5.2.3 Model 3 – after refurbishment (floor changed).....	57
5.3 Comparison.....	58
5.3.1 Comparing models	58
5.3.2 Comparing old and new energy data	59
5.3.3 Comparing net energy demand predictions to simulated net energy demand.	60
5.3.3 Comparing Fixit222 graph to envelope measurement results.	61
6. Discussion.....	63
6.1 Identifying influencing variables and sources of error	63
Coefficients	64
Comparing measured U-value to FIXIT222 graph.	65
7. Conclusions	67
8. References	69

1. Introduction

In 2010, the Ministry of Local Government and Modernisation stated that approximately 40% of all energy consumption in Norway and Europe originates from building energy demand. Since the newbuild to demolition rate is at 1-2% yearly, it will be necessary to focus extensively on rehabilitation of existing building mass if energy efficiency is to be considered effective (Arnstad, 2010). Moreover the Norwegian government want to facilitate energy efficiency, and to collaborate with the EU to reduce energy consumption pr. Gross National Product by 30 % within year 2030 (Meld. St. 25 (2015-2016)).

The institute of Energy Technology reported in 2012 on behalf of SSB that the technical potential of rehabilitating existing domestic building mass to comply with TEK-10 demands is estimated at 13,4 TWh nationwide (IFE / SSB). In Oslo alone, the city council plans to reduce energy consumption in buildings through the “Climate and Energy Strategy for Oslo” by 1,5 TWh. However in SSB’s preliminary energy balance for 2016, domestic and tertiary buildings have increased energy consumption by 3,5 % since 2015 (Fedoryshyn 2017).

A significant barrier to improve energy efficiency in old buildings such as Bergsliens Gate 12B-C is the conservation of historical value. As an 1800’s German style masonry building, BG12B-C is listed in Oslo City Antiquarian’s “yellow list”. This list is made with the purpose of preserving the cultural and antique values of the buildings. This often means that no significant alteration to the façade or structure is allowed.

In a review of a masonry building in Oslo, Gåsbak (2012) found that due to the considerable amount of brick wall area compared to other parts of the construction, 40% of total heat was lost through the outer walls. Windows and doors accounted for 17%.

A possible solution to the balance between energy efficiency and preservation of historical value can be seen in a project in Austria, where a 700 year old mill was rehabilitated by the use of an Aerogel-based plaster (Wakili et al. 2015). Aerogel is a denominator for nonporous materials of which the fluid in the compound is exchanged for gas. By removing the liquid, the thermal conductivity of the material is reduced, hence making it a super insulating material (Schmidt & Schwertfeger 1998). By adding aerogel to lime plaster, it is possible to spray it on the cold side of building envelopes, creating an outside insulating layer that reduces heat loss and simultaneously minimizes altering of façades. Alongside changing of

windows and roof, the insulation of the envelope resulted in a 60% reduction in net energy demand of the mill.

To see if similar results may be achieved in Norwegian climate conditions, the City of Oslo collaborated in the program FutureBuilt and received economic support through Enova to rehabilitate Bergsliens Gate 12B-C using aerogel-based plaster. That leads to the following problem:

What is the insulating capability of aerogel-based plasters in general, and specifically FIXIT222, in Norwegian climate?

Furthermore, secondary objectives include:

- *Is the FIXIT222 datasheet u-value graph applicable in Norway?*
- *How well does the model (SIMIEN), compare to measured consumption?*

Limitations:

- Cost of rehabilitation with Aerogel-based plaster is outside the scope of this thesis. It is acknowledged that since this is a relatively new technique and product, the production process is slow and therefore costly. It can be assumed that production cost will be reduced in time.

To answer the problem, a combination of literature studies, field studies (process observation), and model studies will be used.

The thesis is organised as follows:

- Chapter 1 introduces the problem(s) of the thesis.
- Chapter 2 presents a background to the problem followed by the theory behind aerogel as an insulator, and, ultimately comes a presentation of Fixit222 and previous findings on the subject.
- Chapter 3 covers the methods and equipment applied to reach and present the results.
- Chapter 4 presents the case. The subject building is presented and described by location, building history and technical specifications. Then comes a description of the refurbishing process and the current state of the building. Ultimately, the methods presented in chapter 3 is applied to the case.

- Chapter 5 presents the results of the studies.
- Chapter 6 discusses the results of the research.
- Chapter 7 makes conclusions to the problems based on the discussion.

1.1 Central terms

BG12B-C: Abbreviation for Bergsliens Gate 12B-C

BRA: Usable area. Defined in NS3031:2014 as the area within the building climate screen (envelope). Typically, calculated as total area subtracted the area of the envelope.

CHMO: Abbreviation for the Cultural Heritage Management Office.

Heat Flux: Flow of energy per unit of area per unit of time.

Net energy demand: Net energy demand is the total amount of energy needed without considering energy efficiency coefficients or losses in the supply chain (NS3031).

Tek 87 / 10 / 17: The “Regulations on technical requirements for building works” (hereafter TEK10), was published by the Ministry of local Law and Modernisation on the 26.04.10. Based on Norwegian Standards and recommendation from Sintef Byggforsk, its goal is to heighten the minimum requirements for legally erecting a building in Norway. It states that all building work shall be done in such a way that it ensures reasonable energy consumption, based upon environmentally friendly energy sources. The regulations apply to both new builds and modifications to an existing building (Dibk).

Thermal bridge: an area of elevated thermal conductivity than its surroundings.

Thermal conductivity: The ability of a material to transfer heat

Thermal resistance: a materials resistance to heat flow.

Thermal transmittance (U-Value): The total thermal conductivity of a structure or material (Zagorskas et al. 2014)

Often cited: (Walker & Pavia 2015)

Determination of theoretical U-value according to ISO 6946:2007

(Gaspar et al. 2016)

2. Background and theory

Forty percent of heat in late 1800's masonry buildings is lost through the envelope (Gåsbak, 2012). Although windows generally have the lowest thermal resistance in a building, the relationship between window areas versus total wall area becomes determining. With heating being the main driver of net energy demand in domestic buildings in Norway (Sintef), this should make insulation retrofitting of the exposed walls one of the obvious first choices when planning to refurbish.

The cheapest and easiest way to increase the insulating capacity of a wall is to apply insulation on the warm side. With an added moisture membrane, it will significantly improve the indoor climate and reduce the net energy demand. However, adding insulation on the inside reduces the temperature influence of the part of the wall that is now exposed to weather. In this case, this means that the overall temperature in the masonry bricks drops dramatically. The temperature drop may cause any stored moisture in the bricks never to dry out. In a Norwegian climate where temperatures below zero °C is likely from October to March, there is a possibility of frost with resulting crackling of the bricks (Miljøverndepartementet 2011). Because of the gap between the original wall and the ambient indoor temperature created by the new insulation, it is also likely that the thermal bridge number increases due to cold zones. Despite the before mentioned, the main reason inside retrofitting is not a popular choice is because it reduces the living space area. As an example, to comply to TEK17's minimum requirement for a walls energy efficiency at $U = 0,22 \text{ [W/(m}^2\text{k)]}$, one would have to add approximately 150mm of mineral wool (Figure 44 - Graph depicting U-values .

The obvious option to warm side retrofitting is cold side retrofitting. When adding insulation on the cold side, the temperature inside the masonry bricks is increased, and remains stable like shown in Figure 41. In addition to the insulating layer, a weather resistant layer is needed to prevent water ingress and moisture build-up. It is also necessary to review how far out the insulation extrudes from the original wall in relation to the roof construction, also because of the risk of water ingress. To prevent an increase in the thermal bridge coefficients around the windows, the windows must be moved outward along the insulation (Gåsbak 2012).

The latter method of refurbishing is the more practical of the two, but it is not always desirable (or possible) due to the radical changes of the visual appearance. 1800's masonry buildings like the case in this study are often subject to preservation because of their visual appearance and cultural heritage. Instances such as CHMO and The Norwegian National Conservatory can list these buildings as preserved or yellow listed. If a building is listed as preserved, the "cultural heritage law" legally protects it, and the government must approve all changes. If a building is yellow listed (worthy of preservation), CHMO is entitled to their opinion before an appeal of refurbishing is passed by the Department of planning and building.

TEK 17 states as a general note that all new builds and significant refurbishments must meet the minimum requirements for net energy demands (lovdata). If a building is preserved or is identified as worthy of preservation, measures must be taken to comply to TEK as far as possible without damaging historical value. The combination of meeting the TEK17 energy requirements and preserving historical value is a challenging undertaking (Moen, 2012), but it is not impossible.

To cold-side-insulate a 1800's masonry wall to meet the $U=0,22$ requirement in TEK17, more than 150mm of mineral wool is needed. To make that work, the historical face and details of the façade would vanish.

A serious alternative to these methods of envelope insulation for energy efficiency is Aerogel-based render / plaster for cold side application (Buratti et al. 2016).

2.1 Fixit222 Aerogel Plaster

Fixit222 is an insulating lime plaster manufactured by the Swiss company Fixit. Fixit222 is a mineral compound with the addition of Aerogel granulates.

Aerogels is a group of ultra-light, solid materials with low very density. They are among the lightest materials in existence. The base materials are in most cases a type of silica where the liquid content has been extracted and replaced by gas (air). Because of the near zero percent water content and the low density, Aerogels have extreme thermal resistance and very little mass.

Adding aerogel granulates to the Fixit222 gives the plaster a thermal conductivity of 0.028 W/mK. In comparison, general mineral wool has a thermal conductivity of 0,045 W/mK (Buratti et al. 2014).

Figure 1- Diagram from the manufacturer, showing the correlation between applied thickness and U-value depicts the correlation between applied material thickness and the total U-value of the application from the Swiss refurbishing project “Mühle Sissach”.

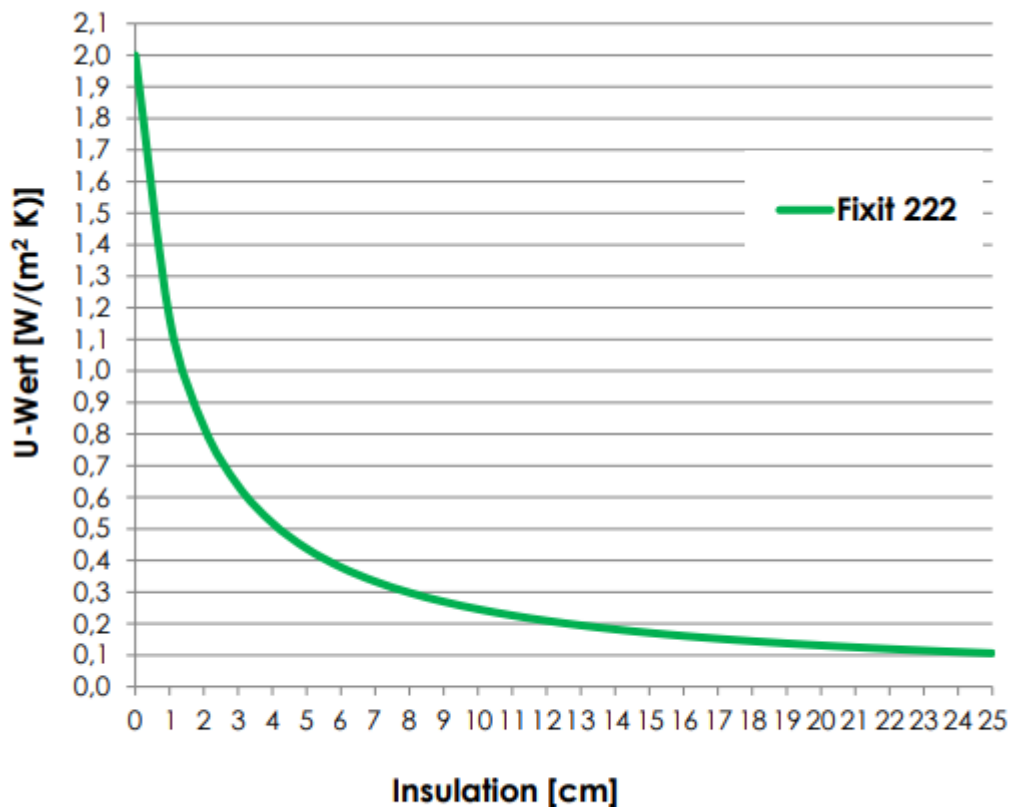

26.2.2014/ S.Hartmeier

Figure 1- Diagram from the manufacturer, showing the correlation between applied thickness and U-value.

Recent studies of the thermal capacities of aerogel-based plaster found that applying 5mm aerogel to a solid stonewall of 600mm thickness reduced the thermal transmittance by 20% (Buratti et al. 2016). Wakili et al. performed a similar study on hygrothermal capabilities of aerogel-based plaster in 2015. They found that applying 40mm plaster and a thin layer of silicate paint on a 600mm stone wall, reduced the thermal transmittance of the structure by 40 %, and greatly reduced the relative humidity inside the structure.

In Switzerland in 2009, Fixit222 was applied to the 700-year-old “Mühle Sissach” as a part of a total rehabilitation and energy efficiency plan. Prior to refurbishing, 48 % of the

heat loss happened through the envelope. In addition to coating all external walls, the refurbishing comprised of window replacement, retrofitting insulation in roof and floor and adding balanced ventilation. Because of restrictions to conserve historical value, no more than the original thickness of plaster was added (50mm). The refurbishment reduced energy consumption in the “Mühle” by 60%.

2.2 FutureBuilt and Bergsliens gate

The first application of Fixit222 in Norway was performed on an old converted stable building in Oslo, which is the case in this study. The project came together when Boligbygg KS wanted to refurbish Bergsliens Gate 12B-C in an innovative way, thinking towards a non-destructive alternative to retrofit insulation on old brick buildings. The project became part of the program FutureBuilt and received economical support by Enova. During the refurbishing, sensors for measuring temperature, humidity and energy consumption was installed, for project follow up. This study is the follow up of results.

3. Methods and Equipment

This chapter describes the methods, equipment and approach utilized to answer the thesis problems.

The overall methodical approach summarizes like so:

Literature studies is used by studying existing documents and records. This method applies to the collection of most model input data and theory behind the case and the equipment. This is a recurring segment in the various subchapters.

The **field studies** mainly comprise of data collection through multiple process observations of the building structure that are explained in detail below. The main variables of the study identify as envelope U-value, weather conditions, indoor climate conditions and energy consumption. Field studies also include surveying the object building to gather data that cannot be found through studies of records and documents.

In energy simulation **model studies**, two models are built. Based on information from data collection and field studies the models are built to represent the building before and after refurbishment. The results of the model simulations are compared, both to each other and to measured energy consumption, as a base of discussion and conclusion. Several means of data comparison are used to discuss both the primary and secondary problems.

(Method overview map is found in appendix1)

3.1 Literature and field studies

3.1.1 Calculating u-value

Determining the U-value of a structure requires detailed information on the layer composition. Thermal conductivity and thickness of each layer material is determined, thereafter an ISO standardized method of calculation is applied, see figure 1.

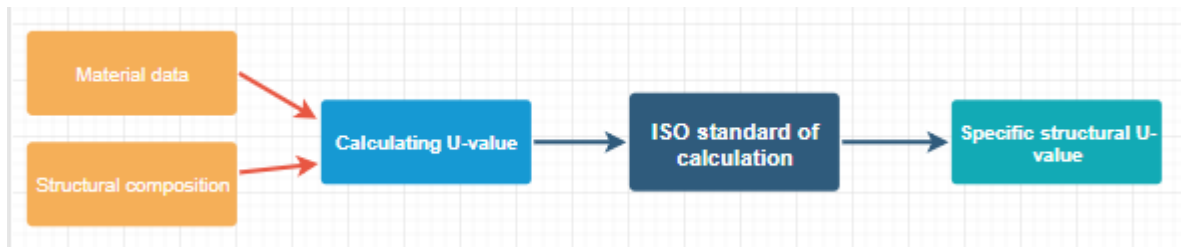

Figure 2- The methodical approach used to calculate U-value, according to ISO standard 6946:2014.

The ISO standard method of calculation (Legges I ref: ISO 6946:2014) utilizes three mathematical formulas, as follows:

(1) Thermal resistance of layer:

$$R = \frac{d}{\lambda}$$

Where:

R = the thermal resistance of a building element layer (m²K/W).

d = the thickness of the layer (m).

λ = the thermal conductivity of the layer (W/mK).

(2) Thermal resistance of a composed structure:

$$R_{tot} = R_{so} + R_1 + R_2 + \dots + R_{air} + R_{si}$$

Where:

R_{tot} = the total thermal resistance of the envelope composition (m²K/W).

R₁... R_n = the thermal resistance of a layer (m²K/W).

R_{so} = the surface to air thermal resistance of the cold side of the envelope (m²K/W).

R_{si} = the surface to air thermal resistance of the warm side of the envelope (m²K/W).

R_{air} = the thermal resistance of air gaps in the construction (m²K/W).

(3) Thermal transmittance of the composed structure:

$$U = \frac{1}{R_{tot}}$$

Where:

U = thermal transmittance (W/m²K)

R_{tot} = the total thermal resistance of the envelope composition (m²K/W)

Formatting data

Calculation of U-value, and the result need no further formatting to serve as model input data.

Validity & Reliability

Specific thermal conductivity of the building elements is gathered from Norwegian Standards and Sintef Byggforskserien. Thickness of the layers are based on inherited data and studies of documents and records and is assumed to be correct. The calculation by ISO standard ensures reliable results.

3.1.2 Calculating transient u-value and moisture content with Wufi Pro

To account for the impact of relative humidity on thermal resistance, and thus U-value the structure is simulated in WUFI (Stahl et al. 2017),(Wakili et al. 2015). It is a tool for simulating hygrothermal properties of a one-dimensional building cross section. In this thesis, a plugin for Wufi called “U-value”, is added to present thermal transmittance values (u-value) of chosen intervals during a simulation period. The data input of the simulated structure is based on the same principle as the manual calculation, with the addition of relative humidity and temperature.

A visual digital representation of the envelope cross section is built. This section contains all the layers with added material properties. The material’s thermal and hygrothermal properties comes from a built-in database in Wufi (containing data from NTNU). The exceptions from the use of the database are the data gathered in this thesis: R-value, material thickness, weather data and indoor climate.

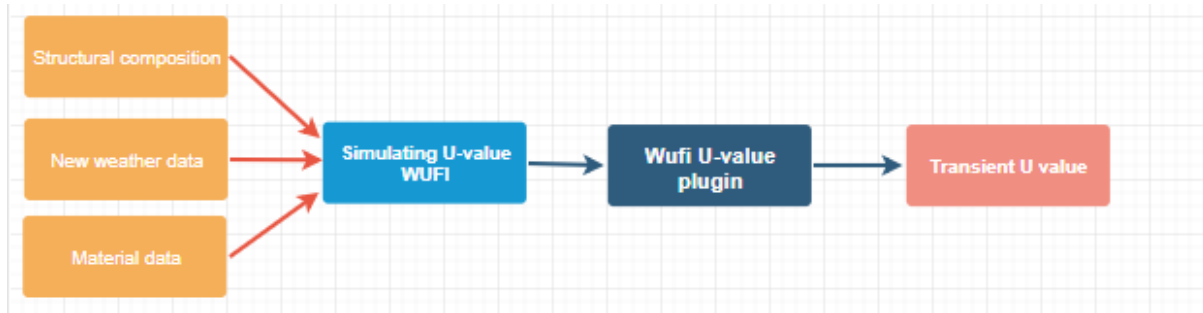

Figure 3- Figure describing the methodical approach of calculating U-value with Wufi.

After the structure cross section is built and properties applied as seen in figure 4, observational points and frequency of observations is chosen.

Nr.	Material / Layer (from outside to inside)	λ [W/mK]	Thickness [m]
1	Gypsum Board	0,2	0,02
2	Solid Brick Masonry	0,6	0,08
3	Gypsum Board	0,2	0,02

Figure 4- Screenshot showing input for material thickness and properties input in Wufi.

Before running the simulation, outside and inside climate data (determined in field study measurements and formatted) is plotted into the program.

The resulting simulation data file needs to be re-run in the Wufi-U -plugin to see the U-value over time scatterplot.

Formatting

The results of the Wufi-U simulation are presented in a scatterplot, which is then exported to a “.dat” file and imported into Excel. There, proceedings include removal of obscure or irrelevant values and calculation of a mean U- value.

Validation and reliability

WUFI complies with the minimum criteria for one-dimensional simulation software for transient heat and moisture content through multi-layered construction.

It uses the ISO standard for thermal simulation and the ASTM (Moisture Analysis and Condensation Control in Building Envelopes) for hygrothermal simulation.

3.1.3 Measuring U-value

Determining the measured U-value through the envelope is based on three steps:

- Thermographical survey of the envelope with an infrared camera to find homogenous spots to measure (Fokaides & Kalogirou 2011).
- Measuring the heat flux and delta T through the envelope over a period of 100+ hours (Sassine 2016).
- Applying American Society for Testing and Materials (ASTM) method of calculation for determining U-value from heat flux and delta T (Thresher & Yarbrough 2014).

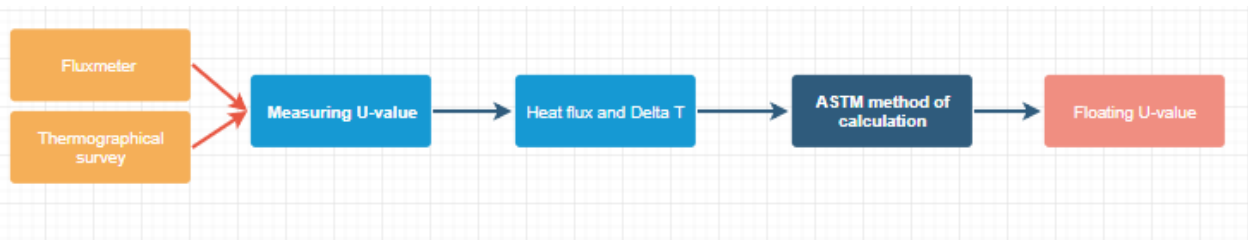

Figure 4- Figure describing the methodical approach to determining U-value through measurements.

A FLIR I3 thermal camera is used to survey the envelope for stable measurement locations. The FLIR I3 is a compact thermal imaging camera for quick and easy thermal photography. It has a thermal sensitivity of 0.1°C and is thus a reliable tool for this purpose.

The Camera is calibrated for the material it is supposed to survey. Set to “steel colour” format, it can identify hotspots on a surface or structure by the heat of the colour. Red through white indicate warmth, while purple through black indicate a cold surface. The camera is pointed towards the structure to find homogenous spots to measure. According to the Hukseflux user manual and ASTM (ASTM C 1046 – 95) it is vital to avoid heat sources, windows, doors and outside surfaces largely exposed to sun radiation.

The envelope U-value is determined from measurements made with a Hukseflux TRSY01. It is a measurement system for determining thermal resistance, R-value, Λ - value, thermal conductance and thermal transmittance in building envelopes or other structures. It consists of two HFP01 heat flux sensors and two pairs of cabled temperature sensors. The HPF sensor is a ceramic-bodied thermopile, which measures heat flux in W/m^2 . The double set of sensors is for redundancy, or the possibility to measure two different envelopes at the same time.

The measurements process comprises of heat flux through the building structure and the delta T (Temperature difference) from one side of the envelope to the other.

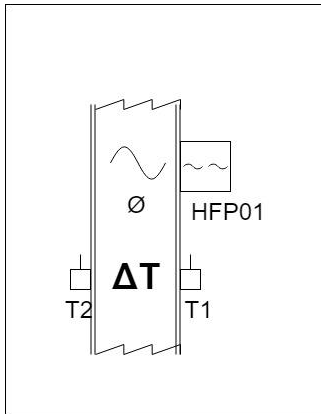

Figure 5- Principle of heat flux measurements through the envelope as seen from above.

After finding a suitable spot with the thermal camera, the HFP01 sensor is placed on the opposite side of the envelope (warm side) to measure heat flux and a couple of thermal sensors is placed on each side of the envelope to measure the temperature difference (delta T), see **Feil! Fant ikke referansebilden**. The logging interval and sensors settings is set by connecting to the TRSY01 through USB-cable to a computer. When initiated, the logging will continue until stopped manually. The raw data is stored in TRSY01's internal memory. The delta T and heat flux measurements require formatting before applying the ASTM method.

Formatting:

The heat flux and delta T - data logged in the TRSY01 is transferred to a “.dat” file through Huxeflux's Loggernet Software. It is then opened as a tabulator -separated database in excel for further proceedings.

	A	B	C	D	E	F	G	H	I	J	K
1	TOAS	CR1000	CR1000	E11797	CR1000,Std,3	CPU:trsys01	23979	HF_10min			
2	TIMESTAMP	RECORD	PTemp	E_HF1	E_HF2	HF1_Avg	T11_Avg	DT1_Avg	HF2_Avg	T21_Avg	DT2_Avg
3	TS	RN	deg C	uV/(W/m^2)	uV/(W/m^2)	W/m^2	deg C	deg C	W/m^2	deg C	deg C
4			Smp	Smp	Smp	Avg	Avg	Avg	Avg	Avg	Avg
5	2018-01-30 15:00:00	7748	16,89	62,97	60,95	2,376	16,88	17,54	0,502	17,05	14,91
6	2018-01-30 15:10:00	7749	16,22	62,97	60,95	-1,01	16,87	19,04	-3,196	18,42	20
7	2018-01-30 15:20:00	7750	15,68	62,97	60,95	9,8	17,5	19,75	23,75	18,28	19,85
8	2018-01-30 15:30:00	7751	15,19	62,97	60,95	-0,049	17,17	16,47	1,35	17,12	14,56
9	2018-01-30 15:40:00	7752	14,9	62,97	60,95	3,48	17,17	16,72	0,398	17,14	15,28

Figure 6 – A screenshot of the data imported to Microsoft Excel.

Determining the U-value from the heat flux, and the delta T According to the ASTM C 1046 – 95, the formula is as follows:

$$U = \frac{Q}{A * (T_{env, h} - T_{env, c})}$$

Where:

Q - Is the amount of heat flux in W/m².

(T_{env, h} – t_{env, c}) - is the difference between the measured envelope temperatures on hot and cold side, respectively. This is referred to as delta T.

A - Is the area of which the measurement is taken (in this case 1x1m).

The formula is applied to the Excel-sheet, and is applied for every iteration of measure. A mean value is calculated from all U-values.

Validation and Reliability:

ISO 9869: Thermal insulation – Building elements - In-situ measurement of thermal resistance and thermal transmittance

ASTM C 1046 – 95 (Reapproved 2001) Standard Practice for In-Situ Measurement of Heat Flux and Temperature on Building Envelope Components.

Measured U-value: The equipment and method used to measure, calculate R-value and furthermore the U-value are validated according to ASTM Standard C1636-11 “Standard test method for Thermal Performance of building materials and envelope assemblies by means of a hot box apparatus”.

3.1.4 Measuring weather data

Temperature and relative humidity outside, indoors and inside the envelope is recorded by an array of sensors. The sensor system consists of data loggers combined with temperature and humidity sensors, and an analysing software tool.

System description:

- 2 x ECOLOG TH1 data loggers with internal temperature and humidity sensors.
- 2 x NTC probes (cabled, combined temperature and humidity sensors, part no. 800637).
- Elprolog Analyze software (Installed on personal computer).
- One holding clamp, designed for adding an additional sensor pair to the loggers.

The logging preferences is pre-programmed into the ECOLOG through USB-cable and Elprolog Analyze. After initiation and placement, the logging will continue until stopped

manually or the loggers run out of battery. Data retrieval is done by removing the data logger from the clamp and connect it to the personal computer via USB.

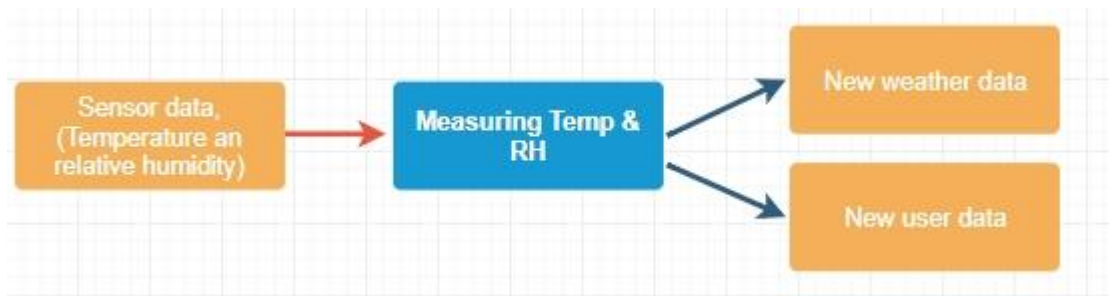

Figure 7- The methodical approach to measuring and formatting weather and indoor climate data.

Formatting

To be able to use the measurements as model input data, some formatting is required.

The field temperature and humidity readings are opened in Elprolog Analyze and needs to be exported to a tabulator-separated “.dat” file to be imported to Excel. To meet its purpose as SIMIEN and WUFI input data, the temperature and relative humidity data needs to fit the format that the software requires. In the case of SIMIEN, it is a 10-field comma separated “.dat”-file.

The measured indoor temperature and humidity is formatted to fit Wufi indoor conditions.

Validation and reliability

The measured weather data is validated through comparison with data recorded by the Institute of Meteorology for the same period from the weather station at Blindern in Oslo. Deviations will be noted and discussed.

3.1.5 Measuring energy consumption after rehabilitation.

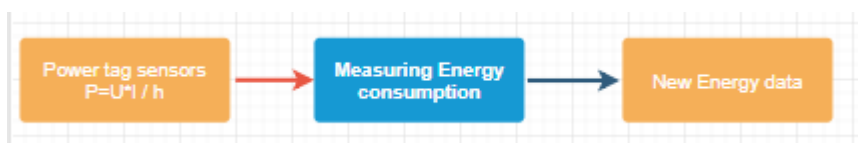

Figure 8- Figure describing the methodical approach to acquiring new energy data using the Power tag sensors.

Measuring the energy consumption for heating living space and heated tap water is done with a Schneider-Electric Acti9 Smart link System.

System description:

- 2 x Acti 9 Smart link SI D

- 7 x Power tags

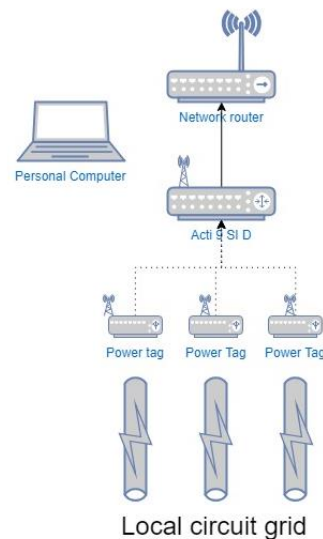

Figure 9- Example of Acti 9 Smartlink system setup connected to the local grid.

The Smartlink SI D is a hub that connects wirelessly to power tags installed in an electric fuse box. The power tags calculate energy based on real time flow of current and voltage. When installed directly on top of the circuit breakers of the circuit one wants to measure, it monitors energy consumption, reports outages and communicate deviations. Connected to a local net or Ethernet through TCP/IP, the Smartlink becomes accessible through a graphical web interface. The web interface displays uptime and total power consumption for each circuit. The readout method from the interface comprise of screenshots or pen and paper.

Validation and reliability: No methods of validation have been found for the measurement method of Schneider Electric Power Tags. However, it is assumed that the methods for measuring voltage and current, and determining the effect is standardized ($P=U*I$).

3. 2 Model studies with SIMIEN

SIMIEN is a building energy simulation software that simulates energy demand and indoor climate in buildings. The software applies the dynamic calculation methods described in the Norwegian standard NS3031:2014. The simulated flow of energy through the subject building is based on weather and climate data, building internal factors and the physical and thermal capabilities of the building structure. The weather and climate data consist of outside temperature, wind speed, relative humidity and sun radiation. By default, Simien has an array of pre-assembled climate databases to choose from based the location of the building. The wind, RH and temperature are gathered from the nearest weather station, and the solar radiation is generated with the software Meteonorm (Programbyggerne). The internal factors include heating, ventilation capacity, water heating, lights, heat radiation from inhabitants, indoor temperature and building operational hours. All the above can be adjusted manually or set to default values (NS3031:2014).

The building structure and thermal capabilities are, alongside heating and ventilation, the most influential variables for heat balance calculation (Programbyggerne). Simien is based on a zone structure, where multiple (similar) rooms can be grouped into zones. Building of the zones require total heated BRA, room volume, area and U-value of envelope and roof structures, area and u-value of windows and doors, and separating structures. Additional values include heat bridge and heat loss coefficient which can be set to NS values.

SIMIEN can be use in several ways, depending on the result sought:

- Summer and winter conditions simulation for estimation of heating and ventilation systems.
- Full-year-simulation, which gives an estimated net energy demand and energy supplied to the building.
- Evaluation of compliance towards Norwegian building regulations TEK10.
- Energy certificate generation as documentation on building efficiency.

This is mandatory when selling or renting out property.

- Evaluation towards passive house standards.

In this thesis, a full-year-simulation is used. Specifically, the net energy demand of the building in kilowatt hours per square meter of heated space (kWh/m²).

In order to simulate the effect of the refurbishing, two model versions of the object building are built (see Figure Figure 10- The approach of the model studies in the thesis.11). One prior to refurbishing, and one after. The first model is mostly based on inherited data, studied records and default values. The second model utilizes the input data gathered and formatted through the field studies. To make the simulation true to the climate in which the building sits, a modified climate database is created, based on the local measurements.

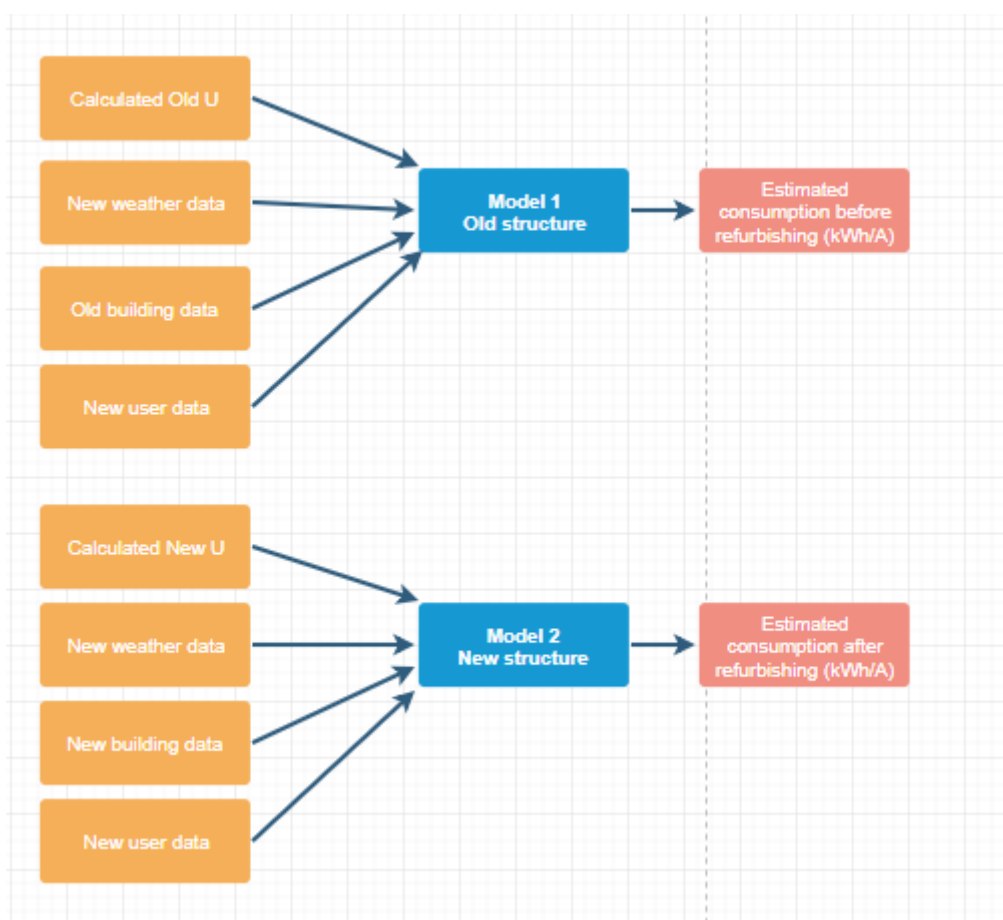

Figure 10- The approach of the model studies in the thesis.

After simulation, the resulting reports are compared to determine the energy efficiency effect. To indicate how well the model reflects reality, the result of the second model is compared to the actual measured energy consumption.

Mathematical equations in the energy simulations are not presented here, as they can be found in NS3031:2014.

3.5.1 Data collection and formatting

The data required to build the models and run comparisons include:

- Building specifications and material data
- Calculated envelope U-value
- Measured climate data
- Measured Energy Consumption
- Measured envelope U-value

Technical building data is generally acquired in three ways:

- Systematic examination of documents and records. This method applies to data that already exist and need no extra effort to be applied to the model.
- Reviewing Norwegian and international standards for standardized values.
- When in need of clarification or additional information, personal interviews and meetings is used.

3.5.2 Validation and reliability

To ensure the correctness of the simulation and the reported results, SIMIEN follows the validation method for building energy simulation software described in NS-EN 15265:2007.

To comply with the dynamic simulation method described in NS3031:2014, a maximum deviation factor of 0.15 towards a reference case is allowed. Simulation tests show that SIMIEN is consistently within consistency class B (Programbyggerne).

Klassifisering	Maksimalt avvik
A	0.05
B	0.10
C	0.15

Figure 11- Classification of deviancy in simulations, according to NS-EN15265:2007.

Model studies with SIMIEN demands thorough knowledge about the subject building. Every data input is sought to be as accurate as possible. When missing significant data or uncertainty occurs, it is assumed that the standard values derived from NS3031:2014 are sufficient.

Collected Building Data – Externally acquired data is assumed correct. Missing data is compensated by standardized values, or physical measurements by standardized methods.

3.6 Comparison

3.6.1 Comparing U-values

To determine if Fixit222 – U-value graph is applicable for this case, the measured U-value is compared to the graph (figure 12)

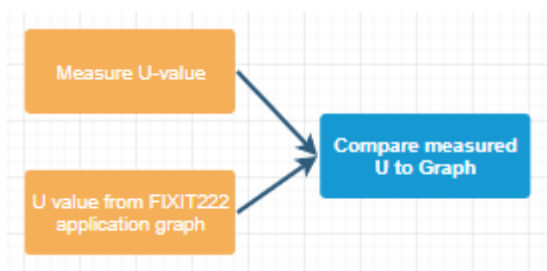

Figure 12- The thesis' approach to comparing the U-values.

The thickness of the plaster added determines the U-value in the graph. The result of the Huxeflux's- measurements will determine if this is applicable for the wall construction in BG12B-C.

3.6.2 Comparing measured energy consumption to old energy consumption

To determine the effect of the actual net energy demand, pre-refurbishing energy consumption measurements are compared to the energy measurements from the field studies.

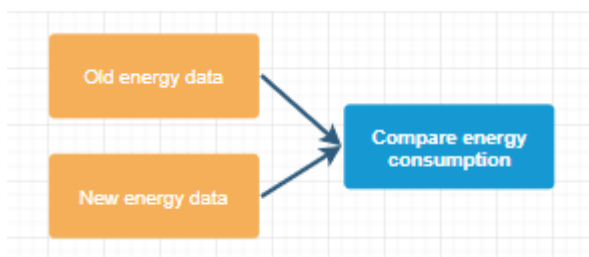

Figure 13- To determine the effect of the energy consumption, the old and the new energy data are compared.

3.6.3 Comparing Simulated energy consumption to Measured energy consumption

The principal method of comparing two models is seen in figure 14.

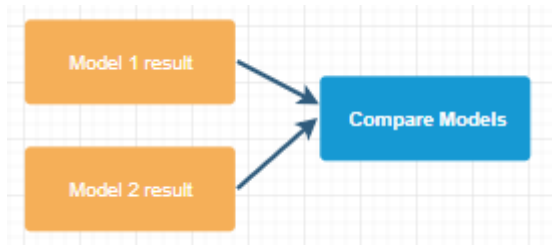

Figure 14- Methodical approach to comparing model results

4. Case Study Bergsliens Gate 12B-C

This chapter presents the case study and the building that is the studied object. Furthermore, it explains systematically, how the method and equipment in the previous chapter is applied to gather and interpret data.

4.1 The building

Bergsliens Gate 12B-C is situated in Majorstuen in Oslo. The building is a late 1800's masonry building and is one of approximately 7000 buildings registered in CHMO's "yellow list", making it a subject for architectural preservation. Originally, it functioned as a stable and toilet facility for the manor house (BG12A) to the northeast. Therefore, the building sits completely within the backyard of a block of surrounding masonry buildings of similar architecture. A few hundred meters to the southwest, lies Bogstadveien, which is a thriving shopping street. Figure 15 indicate position in relation to the Royal Palace.



Figure 15- Overview photo of Oslo, indicating the position of Bergsliens Gate 12B-C in relationship to the Royal Palace.

The image is made using the online map service Norgeskart.

Yellow marking in Image 2 outlines Bergsliens Gate (street). BG12B-C is marked by the red and white dot.

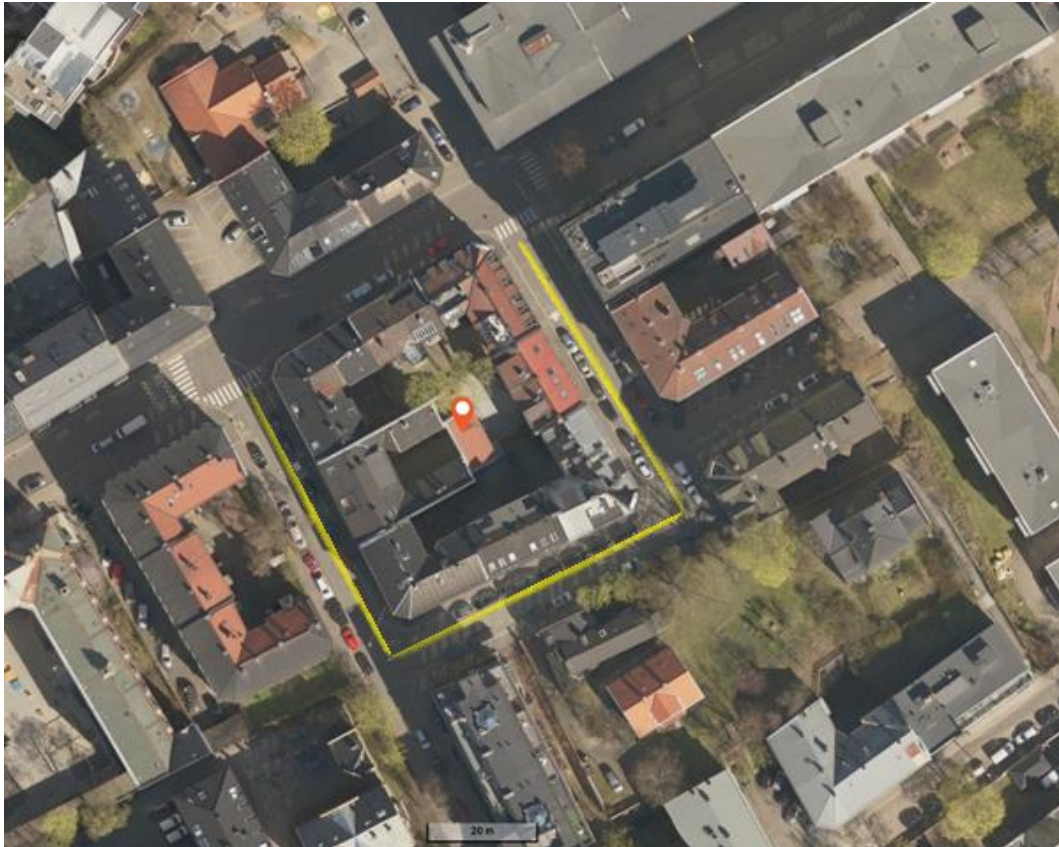

Figure 16- Bird perspective of Bergsliens Gate 12B-C shows the placement within the quarter.

The image is made using the online map service Norgeskart.

Figure 17 (below) shows a 3D representation of Bergsliens Gate. A short survey with the sun shadow tool in Google Earth indicates that BG12B-C is scarcely irradiated by the sun. Because of the tall buildings on all sides, there is little sunshine directly on the façades.

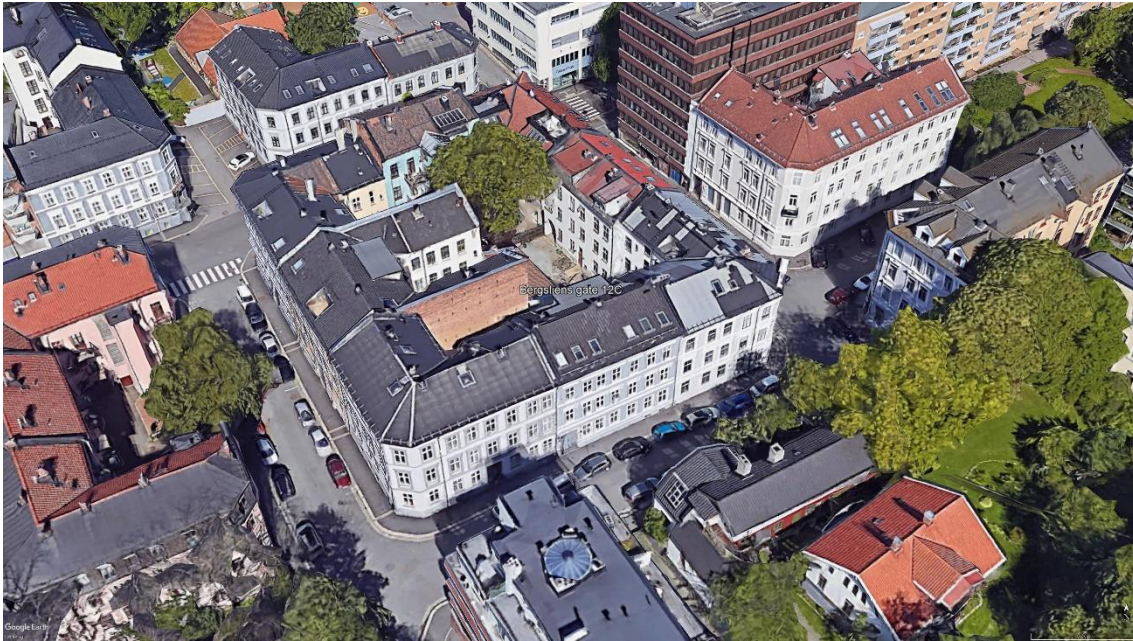

Figure 17- Three-dimensional representation of BG12BC viewed from south. The image is collected from Google Earth.

Figure 18 is a representative photo of the northeast façade after refurbishing. The building envelope is exposed to weather on all sides, except where BG12B-C interacts with Bergsliens Gate 4 as seen by the tall structures of naked bricks.



Figure 18: The northeast façade of BG12B-C after refurbishing. Photo: Eivind Røhne/FutureBuilt.

4.1 Construction history

The building was erected in 1887 and when finished it served as a stable and toilet facility for the manor house (Bergsliens Gate 12A) to the northeast. The composition was then two floors and a manure cellar (Boligbygg, 2016).

The composition of the brick wall consists of 1 & ½- stone solid banded bricks, with lime plaster covering both sides and mortar in between bricks. Wooden joists separate the floors. The northeast façade of the ground floor had one single and one double entrance door to the stable area and three toilet booth doors on the annex as shown in Figure 19. Windows on each side of the doors counts four in total. First floor was used as storage space and had no windows, but a hatch for loading wares. The roof was a pent roof, with sloping only on one side.

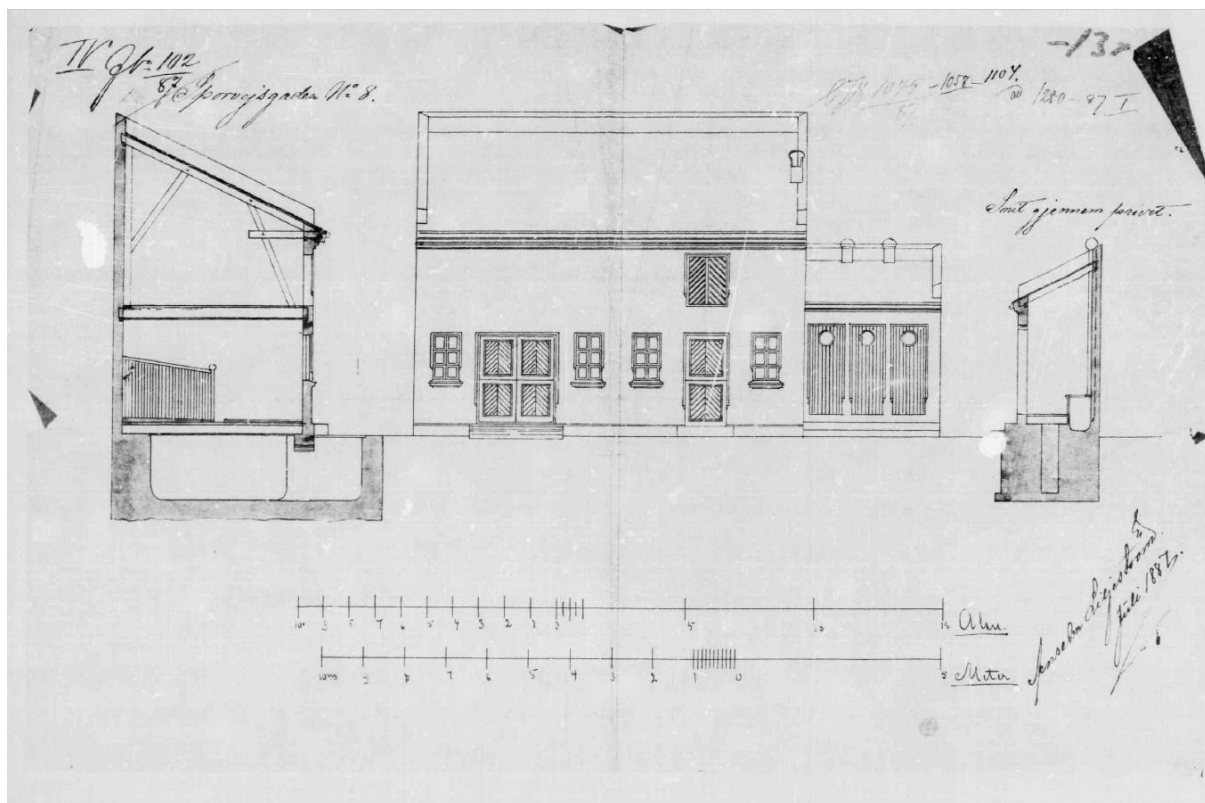

Figure 19: Architectural drawing of the building anno 1887 (Source: Boligbygg).

In 1989 the building was converted into two separate apartments, one for each floor. There were no internal or external stairway leading to the 1st floor, so an additional annex was extruded from the main structure at the far left of the façade. The small stairway annex composed of lime plastered light Leca® blocks and an entrance door. The original toilet

annex on the right side was widened with Leca® blocks to match the breadth of the main structure. The main entrance door to the ground floor apartment replaced the three toilet doors. The two existing doors on the main floor were removed and the windows were changed and repositioned, as can be seen in Figure 20: Sketch from 1988 shows the transformation to apartments. On the first floor, the loading hatch was removed, and four windows were installed.

During the rehabilitation process, the building lost some of its authentic 1800's complexity. Boligbygg has made it an outspoken goal to reimburse the architectural expression of the original building in cooperation with the Cultural heritage management office.

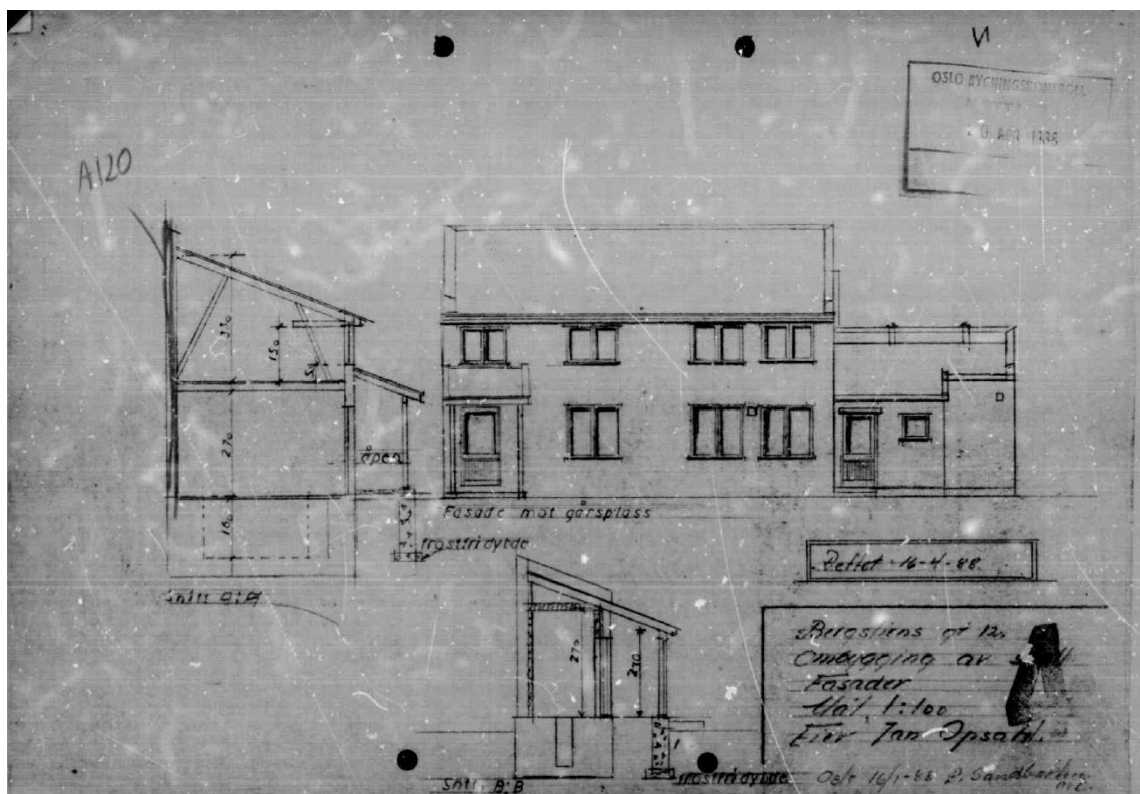

Figure 20: Sketch from 1988 shows the transformation to apartments (Source: Boligbygg).

Boligbygg procured the building in 2004 to serve as welfare housing. The apartments were inhabited until April 2013, when it was decided that the living conditions were too poor to justify continued use (SWECO). The building remained dormant until the refurbishing in 2015.

4.3 Original construction and technical data

Inherited data and data gathered from literature studies:

BRA: 83,3

Cold bridge coefficient: 0,03 (Hole et al. 2011)

Infiltration coefficient: 7 (NS3031)

U-values: 1,18 and 0,80 for envelopes

U-value floor: 1,09

U-value roof: 1

U-value doors and windows: 2,47

Table 1- List of thermal conductivity requirements from Tek87 and values for BG12BC that are either calculated or assumed based on similar structural composition.

Building part	U-value W/(m ² K) indoor temperature > 18 C (Tek87)	Calculated or estimated values for BG12BC (W/(m ² K))
Envelope	0,3	1,15
Window	2,4	2,47
Door	2,0	
Roof	0,2	1
Floor (free)	0,2	1,09
Floor (non-heated room)	0,3	
Floor (ground)	0,3	

The composition of the envelope is built as a 1,5 stone English type cross bond, composed as follows:

Plaster (25mm) – 1 brick (228mm) – mortar (12mm) – Air gap (10mm) – ½ brick (108mm) – plaster (25mm).

Total thickness of original wall: 408mm

Technical building data is gathered from documentation acquired from building owner or contractor. Since the subject building is inhabited, validation of technical data is problematic. Therefore, the assumption is made that inherited building data is correct, as given.

4.2 Refurbishing scope

As part of the FutureBuilt programme and with economic incentives from Enova, Boligbygg commenced the refurbishing as a pilot project to test the effects of Fixit222. In an agreement with the Cultural heritage management office, they set a goal to greatly improve energy efficiency and indoor climate of the building while preserving and restoring the lost original architectural expression. Because this is a test project and although the building is registered in the “yellow list”, CHMO has allowed insulation of the cold side of the façade, based on these premises.

The scope of the refurbishment:

- Drainage and cleaning of the crawlspace cellar and covering it with Isodren® insulation.
- Insulation from cellar towards the heated living space.
- Changing the entire roof construction and the drainpipe system.
- Replacing the windows and doors with new technology windows with mock 1890’s style.
- Installation of balanced ventilation in the ground floor apartment to add sufficient ventilation.
- Decrease possibility of surface water by replacing the asphalt with cobblestone in front of the building.
- Building a bicycle shed with a green roof to reduce the flow of water to the ground.
- Removal of old lime plaster and reinsulate the building envelope with FIXIT system.

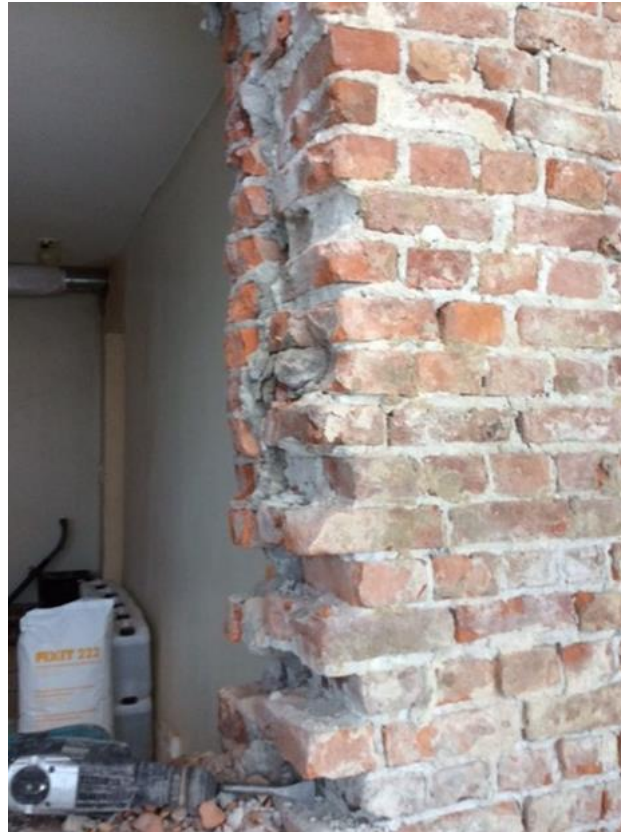

Figure 21 - Picture showing a window cavity after cleaning, before application of FIXIT (source: Boligbygg).

To maintain focus on the problem of the thesis, only the application process of the Fixit-system is described in detail.

4.3 Application of FIXIT222

All traces of the old plaster are removed, and a 3-5mm thick coarse undercoat layer (FIXIT670) is smeared on the clean surface. An undercoat to enhance the adhesiveness of the brick wall is applied before adding the insulation layer.



Figure 22- Image one: The clean surface, ready for application of the undercoat layer. Second image: The surface with an undercoat layer. When the undercoat is dry, a layer of Fixit222 can be applied (Source: Boligbygg).

When the undercoat is dry, a 70mm thick coat of Fixit222 insulating plaster is sprayed on, like shown in Figure 23.



Figure 23- A worker applying Fixit222 with a spray gun ((Source: Boligbygg).

A surface stabilizer (Fixit 493) and a reinforcement mortar (Fixit 223) with a total thickness of approximately 7mm is added after the F222 has hardened. A strengthening fibre textile is

incorporated into the reinforcement mortar. Ultimately the wall is coated with a layer of Weber 249 lime-based paint on both sides of the envelope.

The total added thickness added to the envelope is approximately 80mm on flat surfaces. To preserve the overall impression of the façade, a little less plaster is added around windows and architectural detailing.

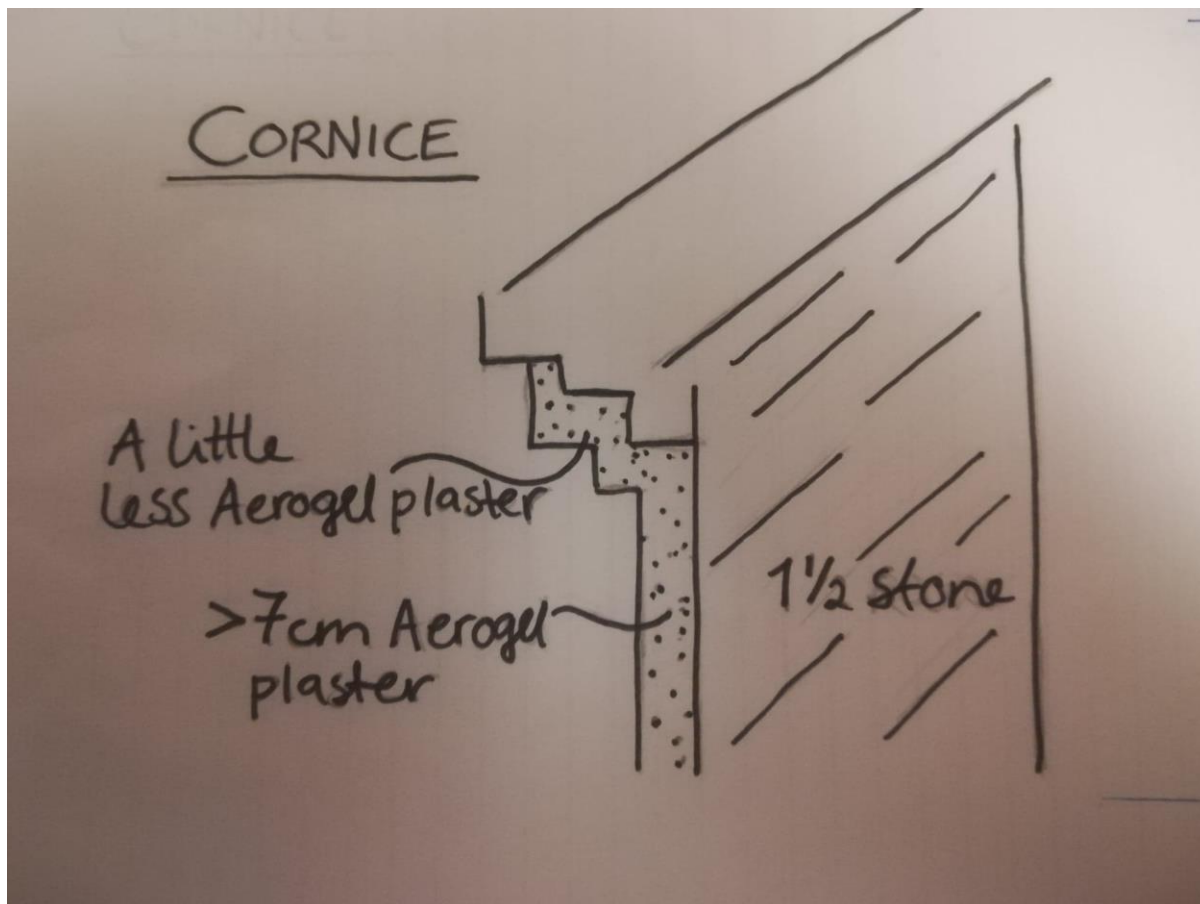

Figure 24- Cross section sketch of the envelope with added Fixit222.

A telephone interview with the contractor revealed that some places, and specially around the windows, the amount of Fixit222 is closer to 80mm.

(Phone interview; Ingvar Røang)

4.3 Construction and technical data after refurbishment

BRA: 83,3

Thermal Bridge coefficient: 0,03

Infiltration coefficient: Model 2 (7) Model 3 (2,5) Tek87 <4

U-values: 0,27 for all envelope

U-values floor: uncertain. Model 2 (U=1,3), Model 3 (U=0,2)

U-value roof: 0,2



Figure 25-Blueprint of the Northeast façade of Bergsliens Gate 12B-C. (Source: Boligbygg).

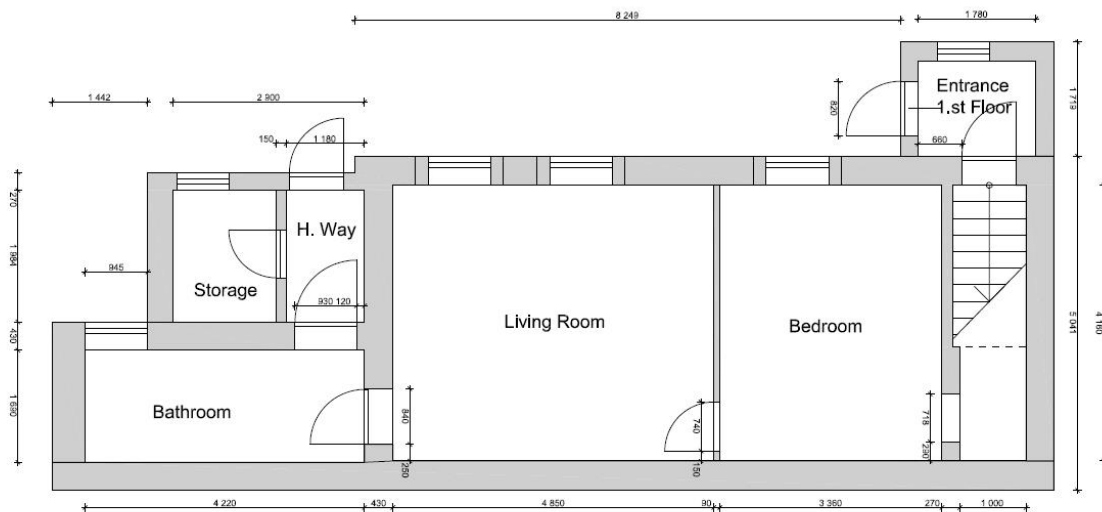
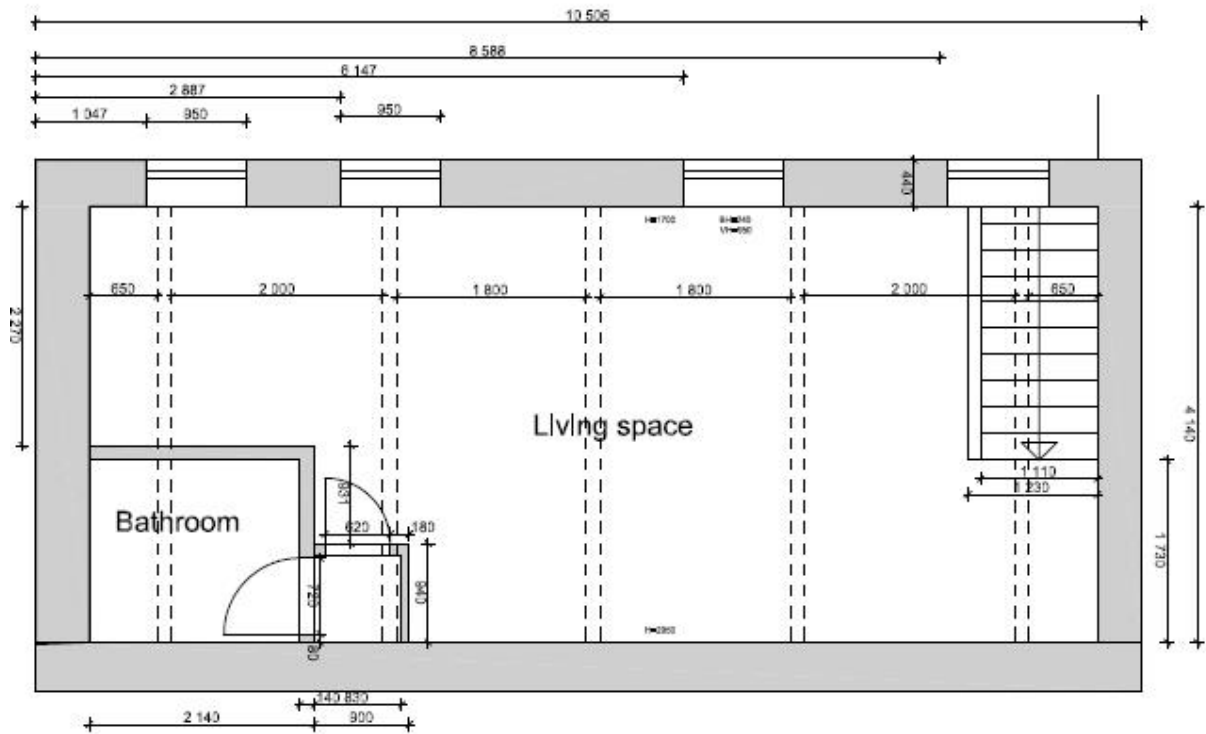

Figure 26- Blueprint drawing of the ground floor plan. (Source: Boligbygg).



Plan view 1.st floor

Figure 27- Blueprint drawing of the 1st floor plan (Source: Boligbygg).

4.3 Literature and field studies

4.3.1 manual calculation of U-value

- Indicative U-values for 600 mm thick traditional stonewalls are as follows:

Uninsulated walls finished with 'plaster on laths': 1.1 ± 0.2 W/m² K (Baker 2011).

Original envelope structure can be seen in table 2.

Table 2- Technical cross section material data prior to refurbishment.

Material	Thermal Resistance	Thickness	R	U (1/R)
Plaster	0,57	0,032	0,05614	
Brick	0,77	0,336	0,436364	
Air	0,18		0,18	
Rsi + Rso	0,17		0,17	
Sum			0,842504	1,186938

Envelope structure after refurbishing is seen in table 3.

Table 3- Technical cross section material data after refurbishment

Material	Thermal Resistance	Thickness	R	U (1/R)
Plaster	0,57	0,032	0,05614	
Undercoat +	0,57	0,05	0,087719	
Brick	0,77	0,336	0,436364	
Air	0,18		0,18	
Rsi + Rso	0,17		0,17	
Aerogel	0,028	0,07	2,5	
Sum			3,430223	0,291526

4.3.3 Calculating U-value with Wufi

Wufi require input of specific heat capacity for each material in the composition. However, FIXIT222 is not represented in the built-in material database. It proved so difficult to find the specific heat capacity of FIXIT 222, that the actual specific heat capacity value is copied from SLENTITE Aerogel insulation board (Filate 2014).

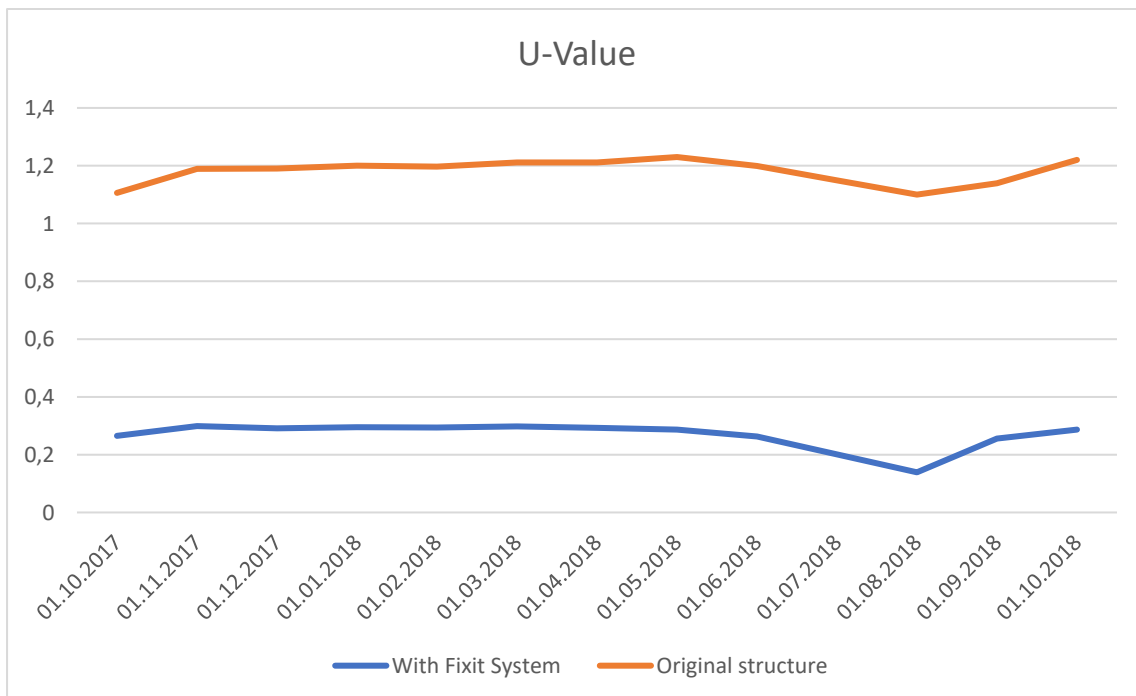

Figure 28- Difference between calculated U-value in original structure and retrofitted structure.

4.3.3 Measuring U-value

Suitable placements for the heat flux and temperature sensors were found by surveying the building envelope with a FLIR I3 thermal camera. A suitable spot would be away from fluctuating sources like windows, heating sources, light and thermal bridges. The survey was performed before sunrise, to make sure that the temperature difference from cold side to warm side of the envelope was as great as possible. In this case the difference was approximately 19° Celsius.

The camera is calibrated by selecting the type of material of the intended survey. In this case, brick wall with a non-glossy surface. The perfect spot was found by pointing the camera at the facade from a distance, looking for the most consistent cold colour. The spot selected for the Hukseflux-measurements is marked by the crosshair in Figure 30.



Figure 29- Using the FLIR I3 thermal imaging camera.

The heatflux-sensors are placed on the warm side of the envelope as shown in Figure 31 along with one of the thermal sensors. The other sensor in the thermocouple are place directly opposite on the cold side.

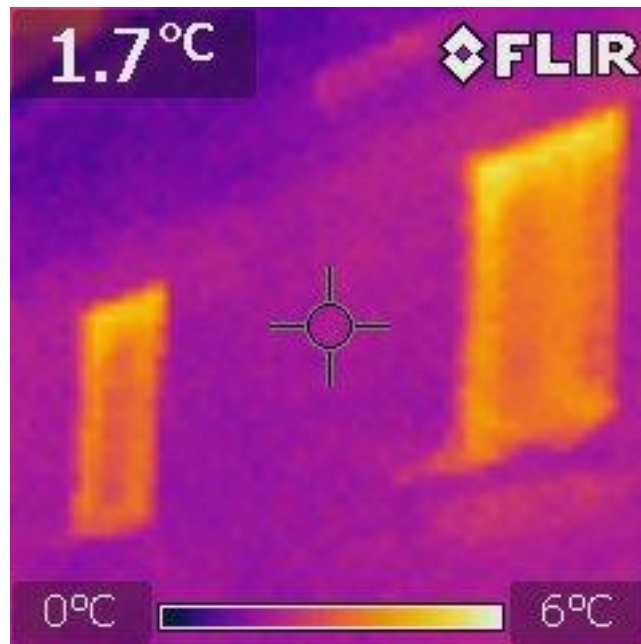

Figure 30- Thermal image of the first floor, between windows.



Figure 31- Red arrows indicating the position of the flux sensors.

The measurements were taken on the southeast wall of the second floor see figure approximately 40 centimetres from the floor and 40 centimetres from the nearest window.

The second sensor group were placed 60 centimetres from the other, at the same height.



Figure 32- Hukseflux TRSYS01 datalogger



Figure 33- Heat flux sensor and temperature sensor (warm side)

In addition to the aforementioned, TRSYS01 logs the surrounding temperature of which the system itself is residing.

After the measurement period was over, a data-file consisting of 715 unique measurements was extracted to a computer and converted to an Excel-file (see Attachments).

Heat flux measurements

The Excel output from the Hukseflux-measurements consists of:

- timestamps (TS) of the numbered (RN) recording.
- system temperature (Ptemp).
- Heat flux in (E_HF1, E_HF2).
- Heat flux density pr. square meter average (HF1_avg, HF2_avg).
- Average temperature indoor sensor (T11_avg, T21_avg).
- Temperature difference indoor-outdoor, delta T (DT1_avg, DT2_avg).

According to ASTM C1636, there are several ways to calculate U-value based on the data collected. The method chosen in this thesis is based on how the thermocouple sensors were fixed to the wall. Generally, thermal transmittance is calculated from $1/R_u$ (Overall thermal resistance). R_u consists of surface to surface resistance + surface to air resistance for both sides of the envelope. Normally surface to air resistance needs to be calculated, but in this case the sensors were deliberately fixed immediately near the wall, as opposed to on it. This means that the surface to air resistance is measured, and the U-value can be calculated

directly from (heat flux / Delta t). This is done for both sensor groups and all numbered values. Plotting this in a graph gives a floating U-value.

From the floating U-value a mean is derived, which is then used in the new post SMI-file.

Because of the rough structure of the paint covering the plaster, -both on the inside and the outside of the envelope, there were some issues with getting the sensors to stick. Solving the issues meant pairs of thermal sensors were used for redundancy. In retrospect, given another shot at measuring, it would be meaningful to find two heterogenous spots to measure.

All sensors stayed on the wall throughout the duration of the measurements, which lasted 119 hours at a registration time interval of 10 minutes.

4.3.4 Measuring weather data.

As a part of the plan to monitor the effect of the refurbishment, it has been installed Temperature and humidity sensors in the building. During the refurbishing progress, a pair of sensors were embedded inside the envelope prior to the application of Fixit222.

Three pairs of sensors are combined to gather a dataset of temperature and humidity from inside the building, outside the building and inside the wall. The sensors inside the wall is enclosed in a hydrophobic cloth and sprayed covered with Fixit222. It resides between the leftmost windows of the front façade on the first floor. The sensor inside is placed in the ceiling of the first floor.

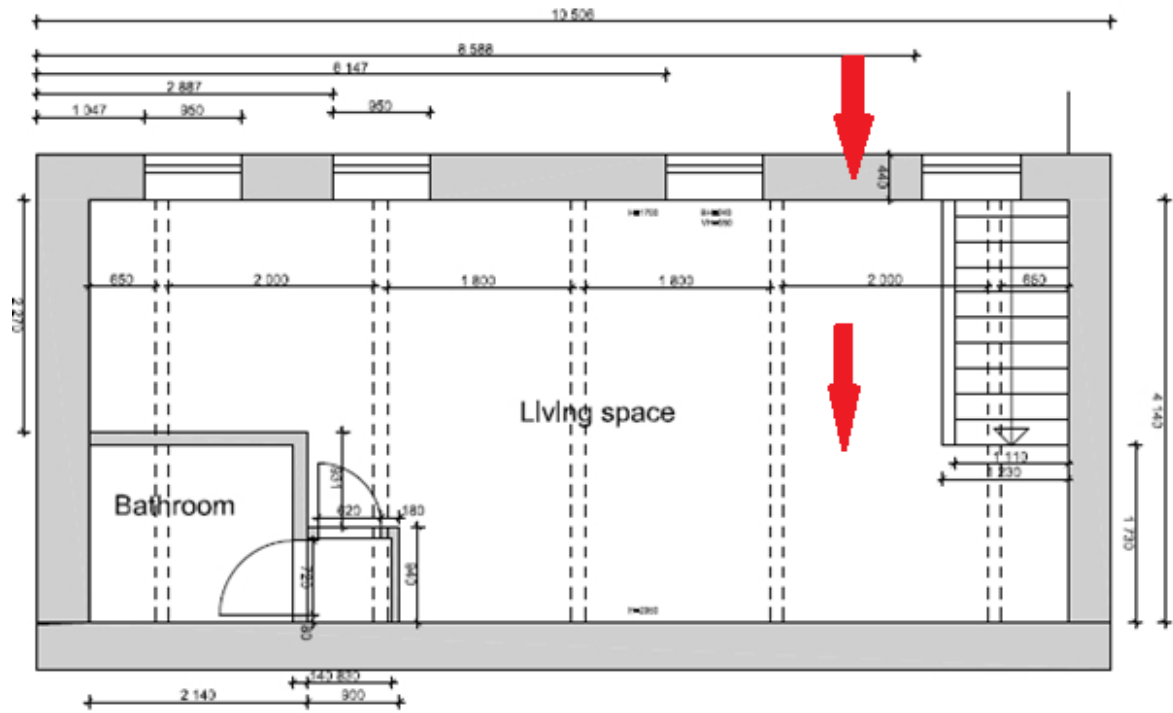

Plan view 1.st floor

Figure 34– The red arrows indicates the sensor placement inside apartment and inside the wall.



Figure 35- Two Elprolog logger units mounted under the cornice.

The monitoring of the apartments as inhabited, started 20.oct 2017, except for the temperature and RH inside the wall. The exception was due to a flat battery in one of the control units. The battery had to be specially ordered from Germany, which took some time. After the battery was replaced, the monitoring did not restart immediately. Regretfully, the RAM-message on the unit that alarmed the dead battery had to be deleted before the CU would operate again. This further postponed the logging, as we were not aware in the beginning. 26.01.18 the internal logging of the envelope commenced.

When reviewing the provisional measurement reports extracted from the Control units, it was noticed that the temperature and RH values indoors were inconsistent. After interviewing the inhabitant of the second floor it came to light that he had been away at a couple of occasions

for a prolonged time. In his absence, all heating was turned off. It was concluded that the pair of sensors in the ceiling of 2nd floor was unfit to represent the temperature picture of the building.

Therefore, a simple Temperature and RH measurement system was bought from the local hardware store. The system is battery operated, and very light, so it was mounted on the wall of the first floor living room.

This was done to find a mean value between the temperatures in the two apartments. This again would help filter out eventualities and odd measurements.

When calculated and formatted, the mean temperature serves as climate input data for both Simien and Wufi.

Validation of local measurements

Weather data from Meteorological Institute for their weather station in Blindern (OSLO) was retrieved 23.02.18. Dates from 20.10.17 to 23.02.18 are applicable for the local dataset. The mean temperature value of each day was extracted from this.

From the Elprolog measurements, temperature data was exported to a .txt-file and Imported to Microsoft Excel. Since there are 8 iterations of measurement each day, the mean value is calculated. Both temperature means from met.no and Elprolog is then depicted in a graph to find how accurate the temperature readings are.

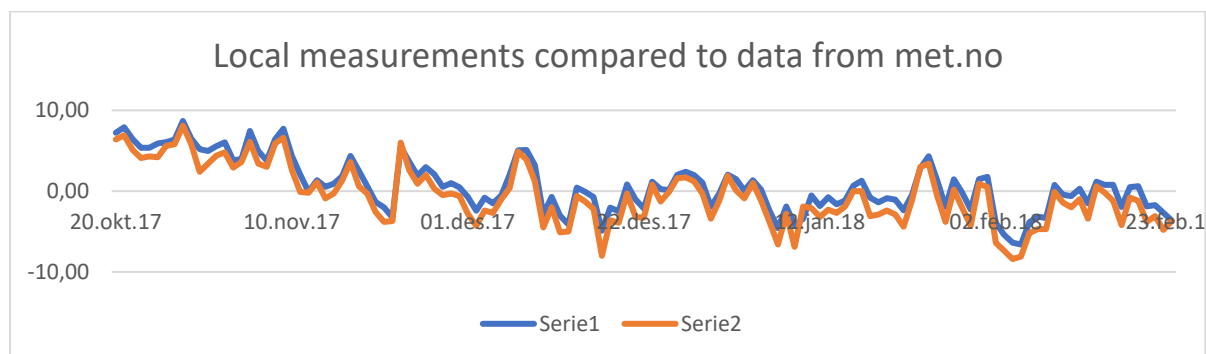

Figure 36- Local measurements compared to data from met.no shows the approximate accuracy of the temperature reading.

4.3.5 Measured Energy consumption

To gather information about heating of the apartments the Power tags installed on every circuit that is mainly used for heating, sends information to the ACTi 9 Smartlink. This includes floor heating, panel ovens and water heaters. Circuits intended for lights and other non-heating electric appliances are not covered (this is a weakness if someone plugs in an oil radiator). To monitor the amount of energy used for heating purposes, each apartment is equipped with an ACTi 9 Smartlink-system connected to the in-house power grid. The system consists of a control unit (ACTi 9) and multiple “power tags”. The power tags are installed near the circuit breakers of the circuits which contain a source of heating. Upon arriving at Bergsliens Gate the first time, this system was not set up properly. It was said that monitoring would be possible to do off site, which turned out not to be true. The circuits were not named, so for a while, it was impossible to distinguish them. This also included heating of water, which would affect the comparison with the simulations later. After a meeting with Boligbygg and a phone interview with Schneider Electric a solution for identifying the power tags was found. The same day the tags were identified, a deal was made with the tenant on 1st floor to send screenshots of the user interface by mail. A preliminary report on energy consumption is aggregated with the use of the old post SMI-file and sent to Boligbygg. Similar approach will be taken when presenting the results in this thesis.

Energy consumption – As the logging of energy consumption only runs from November 2017 to June 2018, the whole-year consumption is subject of calculation and estimation. This is done by splitting consumption into months and comparing it to the Simien simulation.

Prediction Method 1: Based on Simien’s algorithm. Summed up the 31 days of measured consumption in Jan/Feb and factor it against the month of February simulated by Simien.

Method 2: Total measurements: 128 days. $365/128 = 2,8$. Multiply the total measurement (kWh) by 2,8 to find the whole year.

Method 3: Worst case. Multiplying the consumption of Jan/Feb by 12 (months).

4.3.6 Past Energy consumption

Energy consumption prior to refurbishment was gathered through investigating old e-mails and contacting the previous project manager of BG12B-C. E-mail correspondence from Hafslund Nett AS to Boligbygg showed a net energy consumption for the ground floor

apartment of 24397 kW/h during the period of 01.01.2012 to 01.04.2013. To estimate an annual consumption from this number the factor of 365 (days in a year) divided by 456 (days measured by Hafslund) = 0,8 is multiplied by 24397kW/h. This gives a rough estimate of the consumption from 2012 to 2013.

Furthermore, since there are no consumption data from the 1st floor during this period, this is estimated based on the difference factor between 1st floor and ground floor measurements of today. The factor 0,43 is multiplied by the ground floor estimate. The resulting 1st floor estimate is then added to the ground floor estimate to get a total annual consumption estimate of 27951,4 kWh.

4.5 SIMIEN Model Studies of Bergsliens Gate 12B-C

The original plan was to run two models, but because of uncertainties about the significance of the floor insulation, there was a need for three separate models. One with original input data, one with partly uninsulated floor and infiltration coefficient of 7, and one with fully insulated flooring and infiltration coefficient set to TEK10 requirement (2,5h, n50).

All models will use the same climate data generated from the in-situ measurements indoors and outdoors.

5.Results

This chapter presents the findings of the study

5.1 Literature and field studies

5.1.1 Manually calculated U-value

Calculated U-value for previous and new envelope cross section can be seen in Table 4:

Table 4- U-value of the envelope cross before and after refurbishing, and the resulting reduction percentage.

	Old structure	New structure	Reduction
U-value (w/m ² K)	1,18	0,29	75%

5.1.2 U-value as simulated by WUFI U

The resulting mean U- value of the Wufi U-simulation can be seen in Table 5:

Table 5- U- value of the envelope cross section as simulated in Wufi U.

	Old structure	New structure	Reduction
U-value (w/m ² K)	1,18	0,27	77%

5.1.3 Measured U-value

Figure 37 - Graph showing the varying U-value calculated from the measured heat flux and delta T. the “floating” U-value for the envelope. Because the measured variables (temperature and heat flux) are fluctuating, so does the resulting U-value.

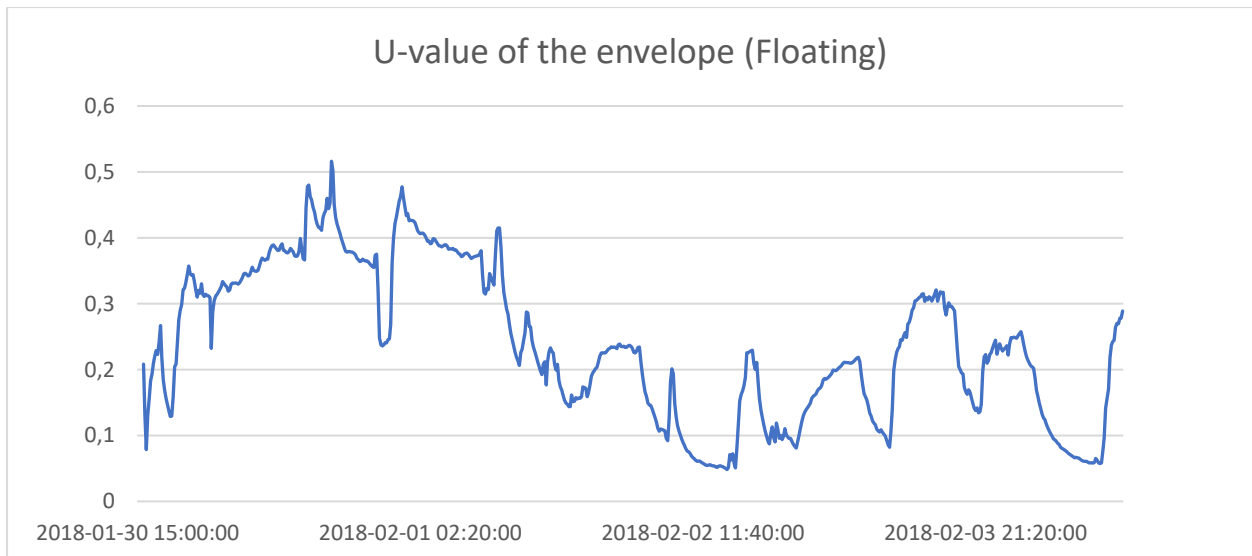

Figure 37 - Graph showing the varying U-value calculated from the measured heat flux and delta T.

The mean U-value derived from the measurements and calculation: 0,23 w/m²K

5.1.4 Measured weather and climate data

Outside temperature and relative humidity from 23.02.17 to 22.02.18 is depicted in Figure 38.

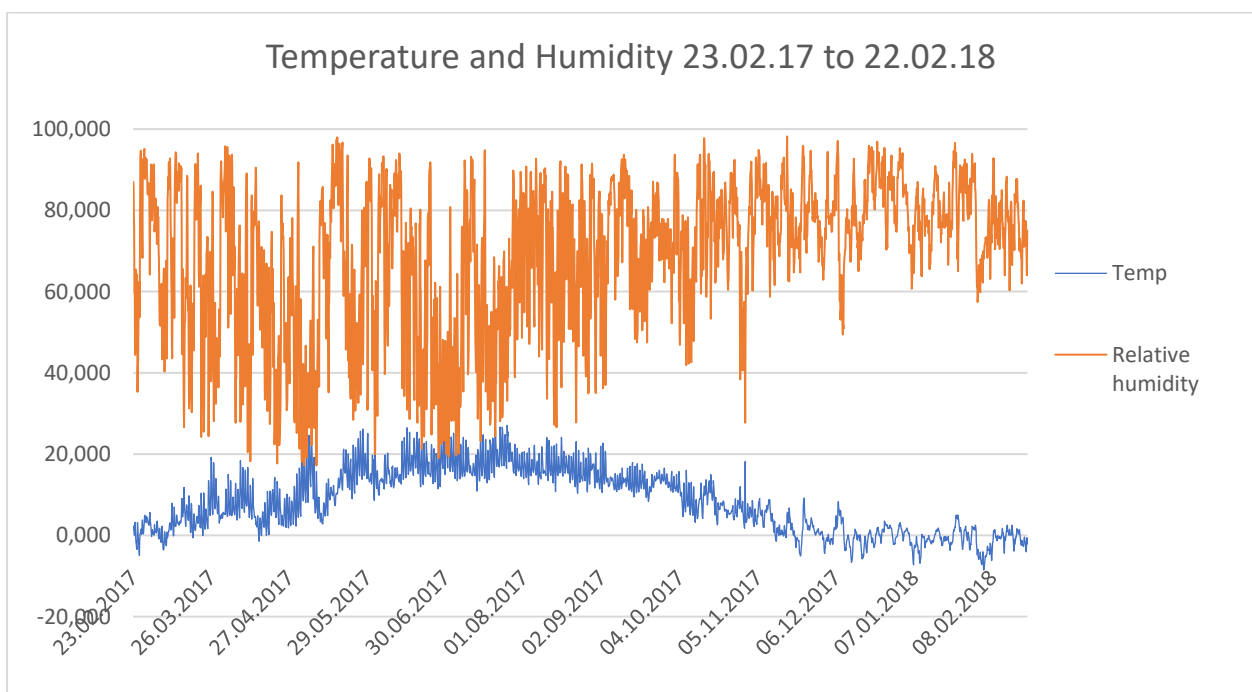

Figure 38- Temperature and relative humidity measurements from outside Bergsliens Gate 12B-C

Mean temperature: 8,267 °C

Mean RH: 68,939

Indoor temperature and RH measurements from the ground floor apartment from 20.10.17 to 22.02.18 can be seen in Figure 39. It should be noted that the drops in temperature is a result of the tenant living there going away for longer periods of time.

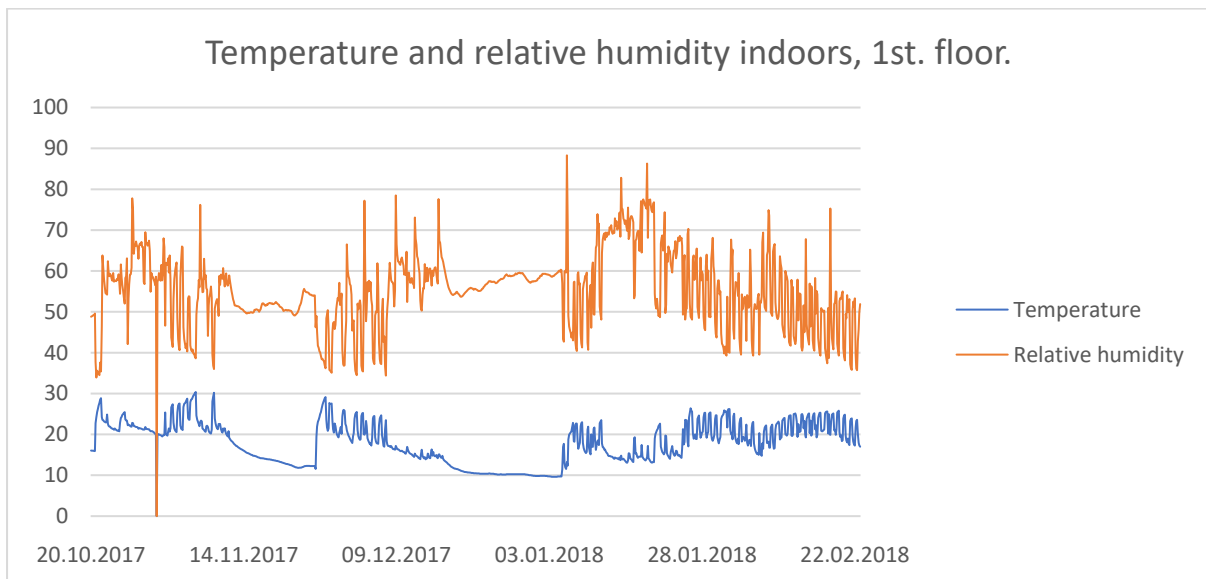

Figure 39 - Indoor temperature and relative humidity measurements (ground floor).

Mean Indoor temperature (1st floor): 17,9 °C

Mean RH: 55,08

Indoor temperature and RH measurements from the ground floor apartment from 28.02.18 to 19.04.18 is seen in Figure 40- Temperature and humidity measurements, ground floor apartment.

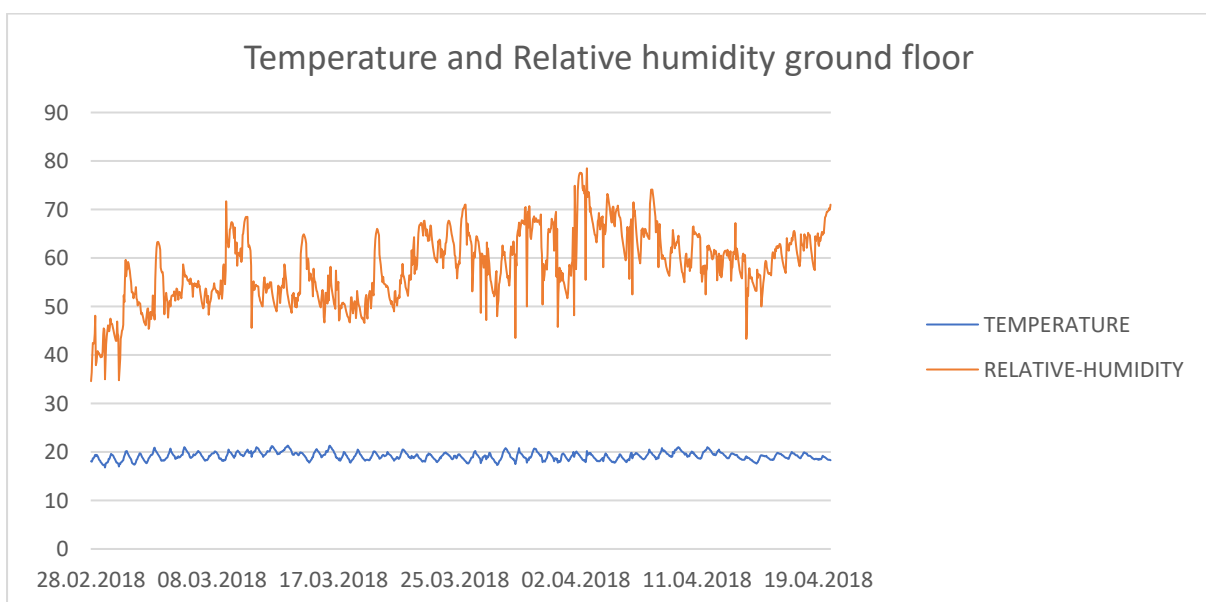

Figure 40- Temperature and humidity measurements, ground floor apartment.

Mean indoor temperature: 19,17 °C

Mean indoor RH: 58,29

Temp and RH measurements from inside the envelope 25.01.18 to 30.03.18 is seen in Figure 40- Temperature and humidity measurements, ground floor apartment.41:

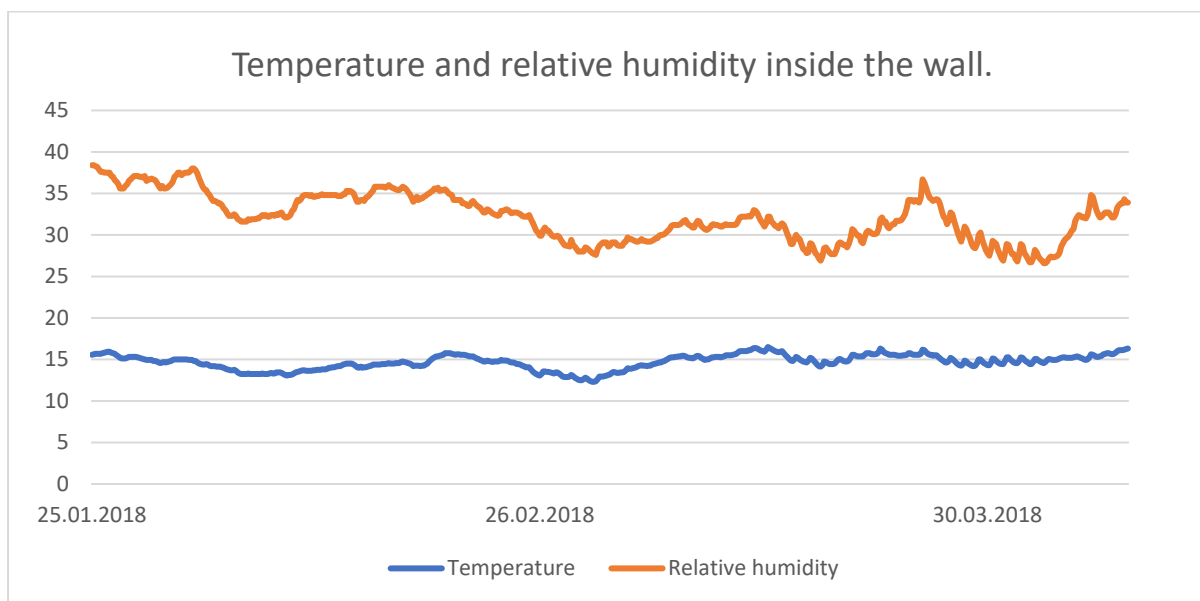

Figure 41-Temperature and relative humidity measurements from inside the envelope.

Mean temperature inside wall: 14,69

Mean RH: 32,14

5.2.4 Measured energy consumption

Measured energy consumption for heating purposes is listed in **Feil! Fant ikke referanseilden..**

Table 5- Specific energy demand from three different methods of extrapolation

	Measured consumption (25.01.18 to 01.06.18)	Annual consumption prediction, extrapolation method 1	Annual consumption prediction, extrapolation method 2	Annual consumption prediction, extrapolation method 3
Total heating energy demand (kW/h)	6116	19051	21413	29370
Tap water energy demand (kW/h)	2382			
Specific energy demand (kWh/m2)	N/A	228,7	257,5	347

5.2.5 Previous energy consumption

Table 6- Energy consumption before the refurbishment. 1st floor is estimated.

Previous annual energy consumption ground floor (est.) (kWh)	19517,6
Previous energy consumption 1st. Floor (kWh) (est.)	8433,8
Total energy consumption prior to refurbishing (kWh)	27951,4
Specific energy consumption (kWh/m ²)	335,6

5.2 Model studies

5.2.1 Model 1 – prior to the refurbishment

Simulated total energy budget before refurbishing can be seen in **Feil! Fant ikke referansebildet..** Heating of living space amounts to 86,5 % of the total energy demand.

Heated water accounts for 5,3 %

Table 7- Energy budget of Bergsliens Gate 12B-C prior to refurbishment.

Energy budget before refurbishing				
Energy post	Energy demand		Specific energy demand	
Heated area	40281	kWh	483,6	kWh/m ²
Ventilation heat	480	kWh	5,8	kWh/m ²
Heated water	2480	kWh	29,8	kWh/m ²
Fans	917	kWh	11	kWh/m ²
Lighting	949	kWh	11,4	kWh/m ²
Technical equipment	1460	kWh	17,5	kWh/m ²
Cooling	0	kWh	0	kWh/m ²
Net energy demand	46566	kWh	559,0	kWh/m ²

5.2.2 Model 2 – after refurbishment

Simulated total energy budget after refurbishing can be seen in **Feil! Fant ikke referansekinden..** Heating of living space amounts to 66 % of the total energy demand. Heated water accounts for 13,3 %.

Table 8- Energy budget of Bergsliens Gate 12B-C after refurbishment.

Energy budget after refurbishing				
Energy post	Energy demand		Specific energy demand	
Heated area	15851	kWh	190,3	kWh/m2
Ventilation heat	647	kWh	7,8	kWh/m2
Heated water	2480	kWh	29,8	kWh/m2
Fans	917	kWh	11	kWh/m2
Lighting	949	kWh	11,4	kWh/m2
Technical equipment	1460	kWh	17,5	kWh/m2
Cooling	0	kWh	0	kWh/m2
Net energy demand	22305	kWh	267,8	kWh/m2

5.2.3 Model 3 – after refurbishment (floor changed).

Simulated total energy budget after refurbishing can be seen in table 9. Heating of living space amounts to 66 % of the total energy demand. Heated water accounts for 13,3 %.

Table 69- Energy budget of Bergsliens Gate 12B-C after refurbishment (floor changed).

Energy budget after refurbishing (model 3)				
Energy post	Energy demand		Specific energy demand	
Heated area	9570	kWh	114,9	kWh/m2
Ventilation heat	633	kWh	7,6	kWh/m2
Heated water	2480	kWh	29,8	kWh/m2
Fans	917	kWh	11	kWh/m2
Lighting	949	kWh	11,4	kWh/m2
Technical equipment	1460	kWh	17,5	kWh/m2
Cooling	0	kWh	0	kWh/m2
Net energy demand	16009	kWh	192,2	kWh/m2

5.3 Comparison

5.3.1 Comparing models

Net energy demand is reduced by 52% as seen in Table 11.

Table 7- Specific energy demand for model 1 and 2.

Specific energy demand model 1 (kWh/m ²)	559,0
Specific energy demand model 2 (kWh/m ²)	267,8
Specific energy demand model 3 (kWh/m ²)	192,2

A visualization of the reduction in heat loss per variable is depicted in **Feil! Fant ikke referansekinden.**

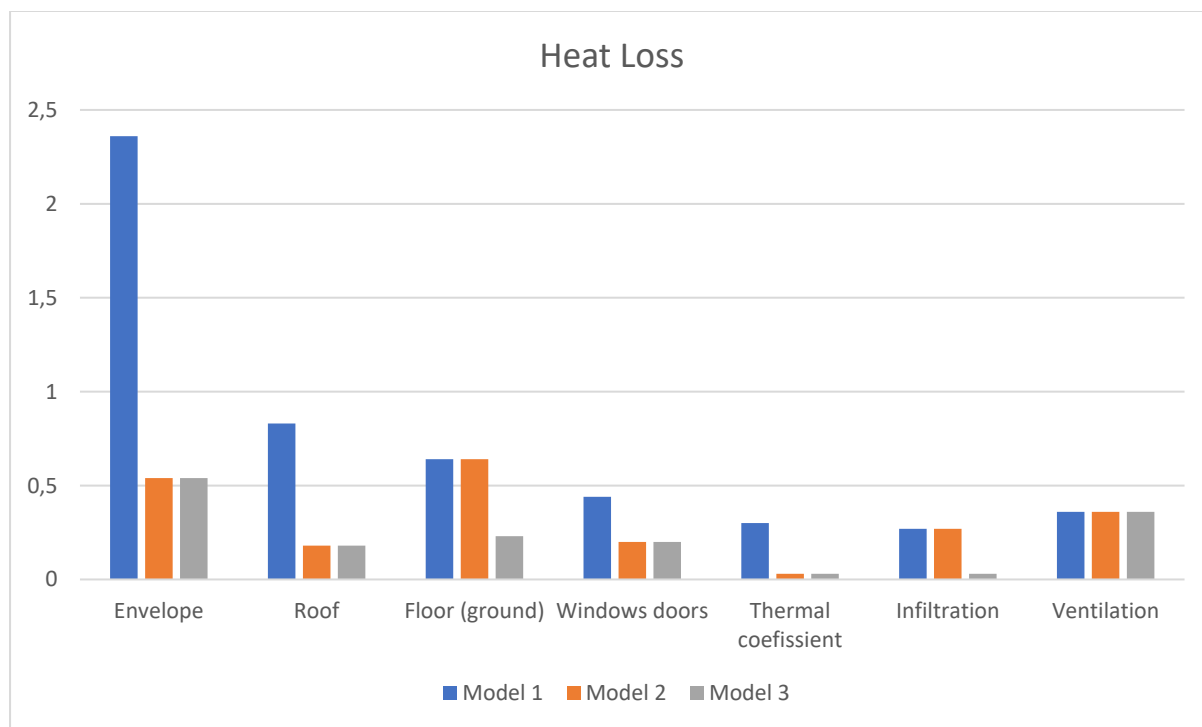

Figure 42- Comparison of heat loss coefficient before and after refurbishment.

Table 8- Reduction in kWh for each specific variable from model 1 (prior) to model 3 (best case after)

Reduction in kWh for each specific variable from model 1 (prior) to model 3 (best case after)						
Variable		Mod 1	Mod 3	Lost heat mod 1 (kWh)	Lost heat mod 2 (kWh)	Reduction in lost heat (kWh)
Envelope		48 %	34 %	19107,572	3499,629	15607,943
Roof		17 %	12 %	6755,606	1183,548	5572,058
Floor (ground)		13 %	15 %	5156,646	1489,638	3667,008
Windows doors		9 %	13 %	3597,66	1326,39	2271,27
Thermal bridge coefficient		1 %	2 %	239,844	193,857	45,987
Infiltration		6 %	2 %	2198,57	204,06	1994,51
Ventilation		7 %	23 %	2918,102	2316,081	602,021

5.3.2 Comparing old and new energy data

Old energy data (specific energy demand): **335.6,1 kWh/m²**

New energy data extrapolation method 2: (specific energy demand): **228 kWh/m²**

The reduction in actual energy consumption is estimated to be 32 %.

5.3.3 Comparing net energy demand predictions to simulated net energy demand.

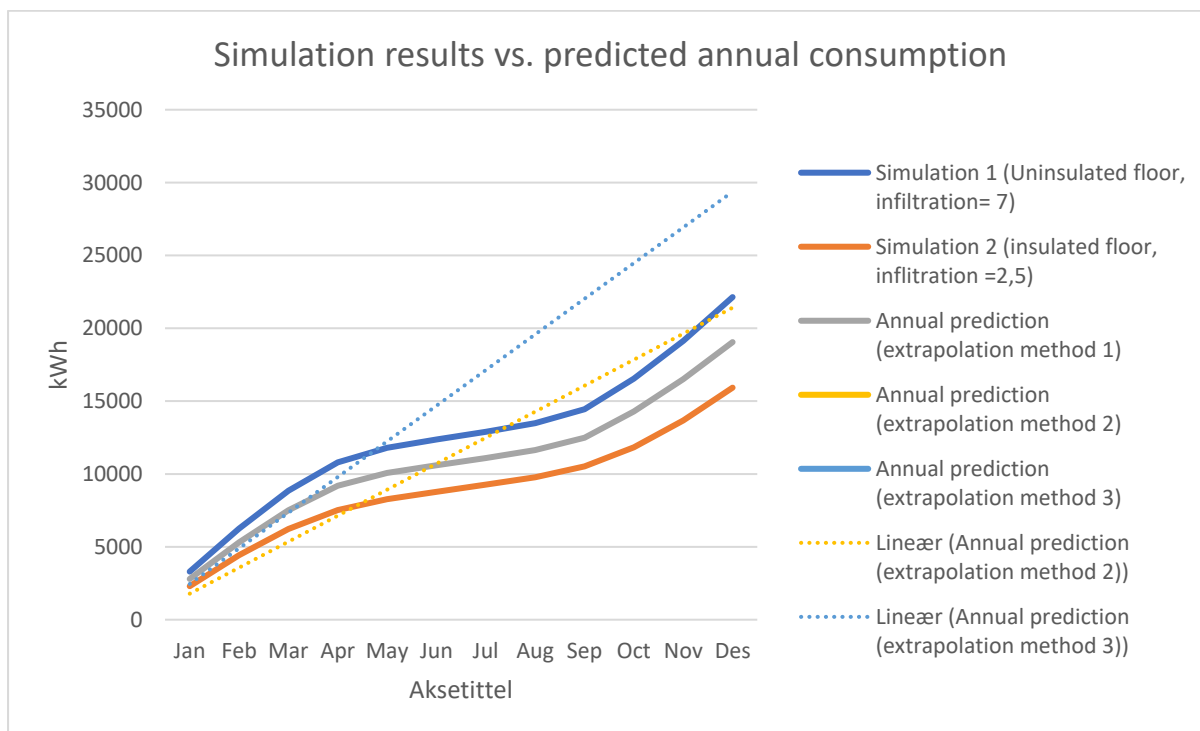

Figure 43- Predicted annual energy consumption, to simulated annual energy consumption.

Figure 43- Predicted annual energy consumption, to simulated annual energy consumption. depicts the difference between the predicted energy consumption based on measurements, and the simulated energy consumption after refurbishment. The blue line represents the result from the SIMIEN-simulations. It shows an annual net energy consumption of 22140kW/h. The orange line represents prediction method 1. Because it is based on the difference ratio between measured consumption and simulated values in SIMIEN, it has the same shape as the other line. However, it predicts a lower annual total of 19051kW/h. The dotted yellow line represents prediction method 2 (half year measurements) and stops at 17430kW/h. The black line “worst case” (Jan. 25. to Feb. 25) estimates an annual net energy demand of 29370kW/h.

5.3.3 Comparing Fixit222 graph to envelope measurement results.

Figure 44 - Graph depicting U-values display the calculated U-value of the original wall ($U = 1.18$), the measured U-value after refurbishment ($U = 0,23$), and reference U-values varying by applied thickness (Fixit222 and generic mineral wool).

Figure 44 - Graph depicting U-values of original structure, measured new value and u-value of Fixit and mineral wool in relation to thickness applied.

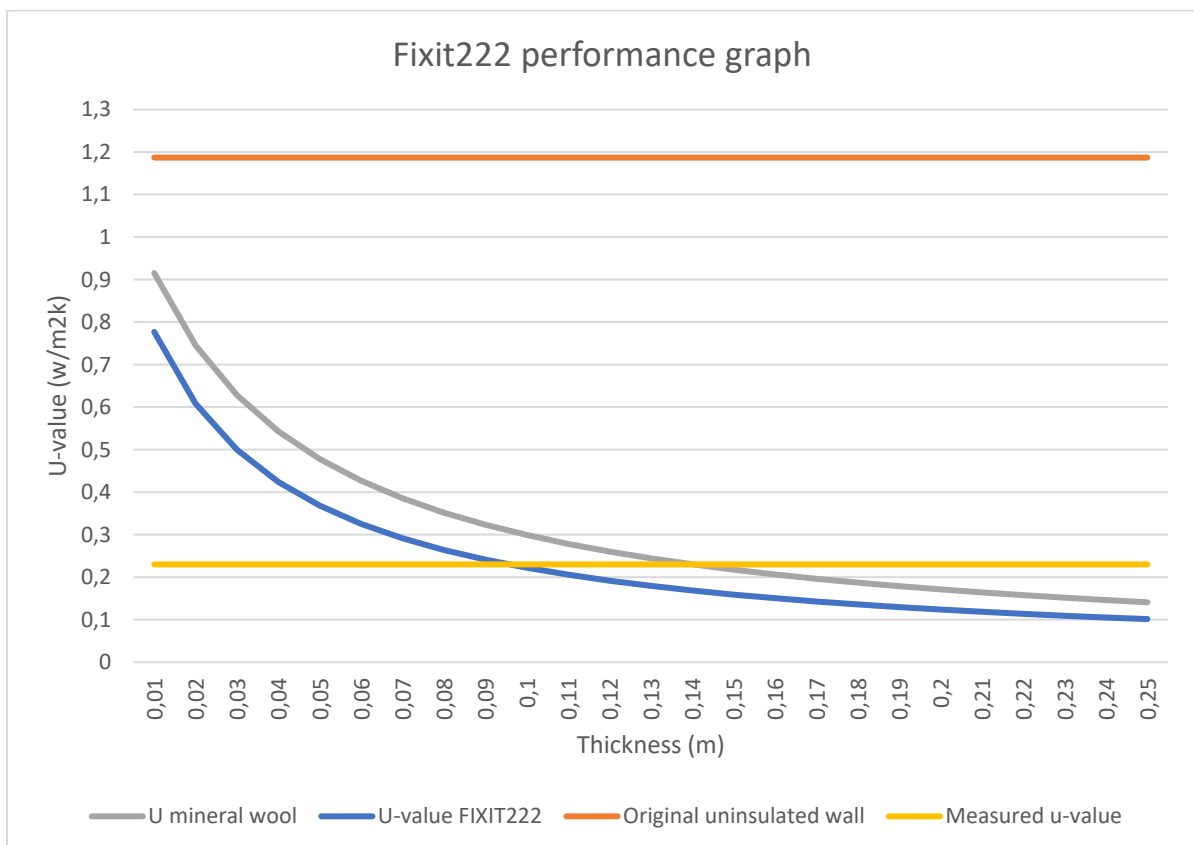
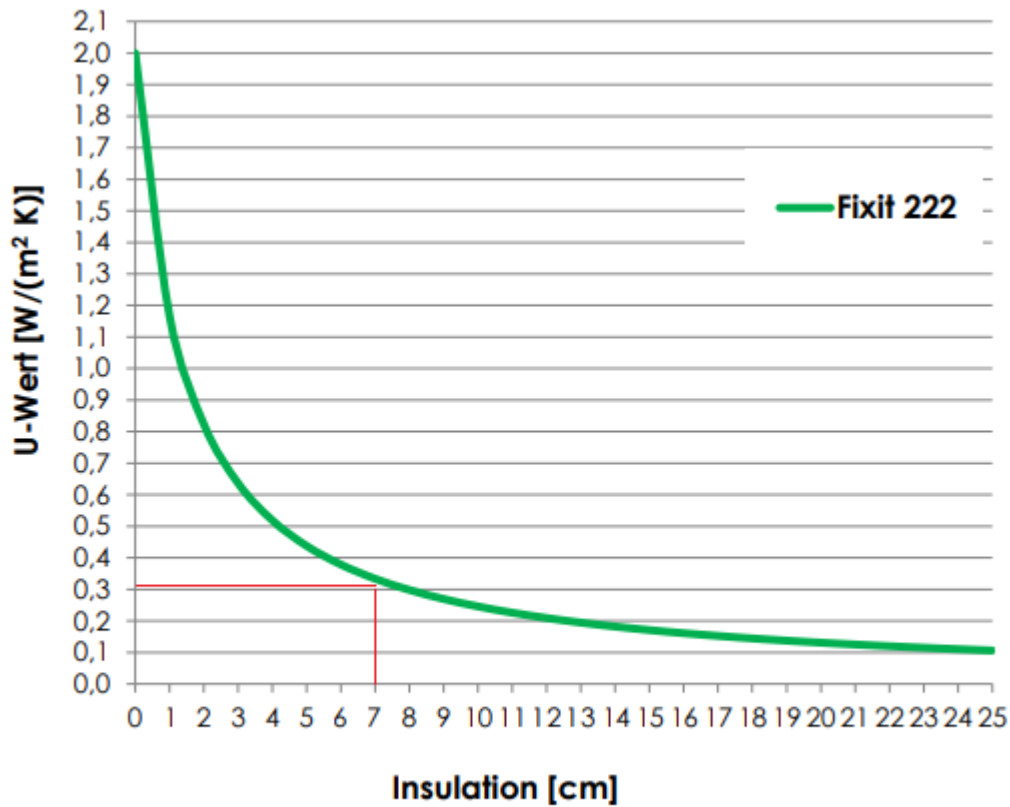

Figure 44 - Graph depicting U-values of original structure, measured new value and u-value of Fixit and mineral wool in relation to thickness applied.



26.2.2014/ S.Hartmeier

Figure 45- Manufacturers performance graph for FIXIT222

The intersection between measured U-value and U-value FIXIT222 in Figure 44 lies between 0,09m to 0,1m thickness. To reach the same U-value with mineral wool, one would need 0,14m applied thickness.

The marked line in Figure 45 indicates a U-value of 0,27 with 0,07m applied thickness.

6. Discussion

Comparing model 1 and 2 gives a reduction in specific net energy demand of 52 %.

Comparison of model 1 and 3 show a reduction in specific net energy demand of 65%. The last result is close to the reduction in net energy demand of a similar brick building that was found in the report Gåsbak et al. wrote for “Riksantikvaren” in 2012. When adding together the effects of five different refurbishing methods without regard for preserving historical value, they achieved a simulated reduction of net energy demand of 71 %. The scope of the simulated refurbishment included lowering the temperature at night from 21°C to 19°C, reducing infiltration to Tek10 requirement (2,5h-1), 150mm cold side envelope insulation (mineral wool), 300mm insulation of roof and flooring and replacing all windows. Additionally, forced ventilation with recycled heat was installed.

The similarity between the two simulation reports strengthens the liability of the results.

When comparing the estimated previous consumption based on measurement data with the new measured data (extrapolation method 1), the reduction in specific energy demand is estimated to be approximately 32%. This is a bit lower than the difference between the models 1 and 2, and a lot lower than the difference between model 1 and 3 at 65%. There may be several sources of error that can result in such a big gap between simulated and estimated energy consumption.

6.1 Identifying influencing variables and sources of error.

The largest gap between simulated and estimated data is the consumption prior to refurbishing. The simulated specific energy demand of 559 kWh/m² is 39% higher than the estimated consumption based on previous measurements. The biggest issue when comparing the two, is that the inherited data from Hafslund only contain measurements from the ground floor apartment. Also, the total consumption is summed up over 15 months. This gives two sources of error. Firstly, the estimate of the annual consumption of the ground floor, then the 1st floor consumption based on the difference factor calculated from new measurement data.

Another possible source of error is the outdoor climate. In this case, no recorded weather data from 2012 to 2013 has been retrieved, so the need for heating back then may have been different from the climate from 2017 to 2018 (measured -> Simien climate database). Of course, the weather data is possible to find. Indoor climate (user data) is also an issue. The indoor temperature measurements from Oct. 2017 and onward have indicated a set point

value to adjust Simien to when it comes to indoor temperature. However, indoor climate is very varying depending on the building and the clients.

In contrast to an office building, the inhabitant's individual preferences of comfort have a significant impact on the energy demand of a domestic building. An office building may have a temperature scheme and a set temperature for office hours and non-office hours. Also, they usually have balanced ventilation, and a set of "rules of conduct" for the workers to follow. Personal preferences are not prioritised in the same way as in one's own home.

During the temperature measurement period in Bergsliens gate 12B-C, the inhabitant on the 1st. floor went away for several occasions, sometimes for weeks at a time. Before departing, the tenant had shut down all sources of heating except the water heater. This had a profound impact on the temperature readings, as can be seen in Figure 23. Upon interviewing the tenant about this it was informed that he does not use the floor heating in the bathroom, and that he likes to air out the apartment regularly. The latter can be seen by the frequency of the temperature drops in the same figure. It is assumed that this has had an impact on the energy consumption in the models, as the same climate data is used for all models.

Because of the above, and the fact that the first indoor temperature sensor was placed in the ceiling of the 1.st floor apartment, another temperature and humidity sensor was installed in the ground floor apartment. Results can be seen in Figure 24. The measurements from the ground floor apartment are stable and predictive compared to the 1st floor. Despite having the advantage of heat transfer from the ground floor, the upper apartment mean temperature is 1,2 °C lower. By default, increasing or decreasing the indoor temperature by 1°C affects the net energy demand by 5% (Gåsbak 2012).

Coefficients

Thermal bridge coefficients in uninsulated brick buildings tend to be very low. The coefficient is calculated by the loss of heat (W/mK) divided by the length of the thermal bridge, and since the wall is practically its own thermal bridge without insulation, the coefficient is near 0. Normalized thermal bridge coefficient from NS3031 is 0,03 W/mK (Næve, 2009). Since Fixit222 is applied on the cold side of the wall, it is not anticipated any increase in the thermal bridge coefficient. However, to account for uncertainty and the possible thermal bridges in the connections between floor and external wall, the coefficient was increased to 0,22 W/mK and a new simulation was run. This increased the energy demand by 0,05% which is an insignificant increase.

Infiltration coefficient: In a custom scenario simulation, the infiltration coefficient was reduced from 7 to 2,5 (Tek10) without the added effect of Fixit222 on the thermal transmittance. It reduced the SED from 559 kWh/m² to 400 kWh/m². It seems that air infiltration has some impact on the result, as it reduces SED by 7%. However, it is hard to reduce the infiltration alone, without insulating. If Tek 17 infiltration requirements were to be met at 0,6 m³/h, the SED would be 189kwh, a reduction of only 3,2kWh/m². This indicates that a building like this would gain little by approaching passive house standards.

Simulations vs. measurements

New measurement data vs. simulated energy demand. The comparative diagram for both estimated and simulated energy demand can be seen in figure 30. The specific energy demand values are seen in tables 8, 9 and 10. The simulation of model 2 (uninsulated floor, infiltration 7) and the extrapolation method 2 (128 days measure) are the closest to each other with 267,8 and 257,5 kWh/m² respectively and a difference of only 3,9 %. The difference between the extrapolation method 1 (Simien factor) and simulation of model 3 is 18%.

Temperature and humidity

The temperature and humidity results in figure 41 indicate that both the temperature and relative humidity is stable, and well above dew point always, even during the coldest winter season. This is a good sign for the preserving of historical buildings.

Comparing measured U-value to FIXIT222 graph.

The mean U- value determined from the heat flux measurements as seen in figure 23, is 0,04 w/m²k lower than the value calculated with ISO6946. The comparison between the two add up a multitude of different variables, and therefore potential sources of error. The best-known sources of error when measuring heat flux through a wall, is insufficient contact between the hfp01 and the wall surface. In ideal conditions, heat flux measurement in building physics can attain up to 6 % uncertainties. That means that the measurement of 0,23 W/m²k can differ by +-0,01 W/m²k, during the best conditions. In addition to that, the ASTM standard for in-situ measurement states that the best results are gained when outdoor temperature and indoor ambient temperature stay relatively homogenous. As can be seen in figures 24 and 25, this was not the case. It should be mentioned that the dynamic method of heat flux measures is mostly applied to offices or public buildings, where the climate is more stable. No records of application to domestic buildings have been found.

The uncertainties regarding the manually calculated U-values is usually based on wrong input data. The calculation requires knowledge about material thickness, thermal resistance of the materials and the composition of the materials. The thermal resistance in turn relies on material density and moisture content among other variables (Gloria Gomes et al. 2017). With 120-year-old bricks it is difficult to know these properties without lab testing. In the case of BG12B-C, Sweco drilled out a core sample of the wall, revealing an air gap that was not believed to be present. This air gap adds some thermal resistance.

Recent studies imply that dynamic measurements of U-value, with large datasets have lower than $\pm 1\%$ difference rate from the ISO calculation method (Gaspar et al. 2016),(Li et al. 2015). If applying these findings to BG12B-C and the difference between calculated $U = 0,27$ and measured $U = 0,24$, it is possible to think that some data errors exist in either composition, thermal resistance or material thickness of the wall structure. The significance of $U = 0,04$ (W/m²k) less for the whole envelope in Bergsliens Gate account to a reduction in specific net demand of 8 kWh/m², which is less than significant unless simulating a passive house.

7. Conclusions

Estimates from this thesis suggest that the energy demand from Norwegian 1800's brick buildings would be reduced significantly if retrofitted with FIXIT222. Because of its jointless application to the cold side of the envelope, it not only reduces the thermal transmittance of the wall, but also works as a thermal bridge breaker and will possibly reduce the infiltration coefficient to a near Tek17 level.

The simulations show that when adding a layer of 70-80mm Fixit222, accompanied by gentle refurbishing of roof and floor, and replacement of windows and doors (1800's replica) it is possible to reduce the total energy demand by 50 – 70 %.

Singling out the effect of Fixit222 sees a reduction in net energy demand by 38 % due to u-value reduction, infiltration reduction and cancellation of thermal bridging. The possibility of joint free application and possibilities of flexible moulding makes Fixit222 significantly less destructive of historic value than traditional insulation methods.

Measurements sees a reduction of energy for heating purposes of 59% compared to simulated pre-refurbishing.

By applying insulation on the cold side of the building envelope, the temperature inside the wall is increased and the risk of crackling and moisture build up is reduced to almost none. At the same time, the negative impact on historical values are minimal.

When comparing the in-situ measured U-value of the plastered envelope in this case with the Fixit222 performance graph from "Mühle Sissach" it can be concluded that the graph is applicable to late 1800's brick buildings in Norwegian climate.

Thought about fields of further studies:

- Cost-benefit study: although outside of this thesis, it is noted that the production of Aerogel plasters is costly and time consuming. It also takes some time to apply to a building.
- Fixit222's effect on infiltration and thermal bridges
- Prolonged testing of Fixit222's resilience and ability to withstand water ingress over time.

8. References

- Baker, P. (2011). *U-values and traditional buildings*. Technical paper 10. Tilgjengelig fra: www.historic-scotland.gov.uk/technicalpapers (lest 01.06.18).
- Buratti, C., Moretti, E., Belloni, E. & Agosti, F. (2014). Development of Innovative Aerogel Based Plasters: Preliminary Thermal and Acoustic Performance Evaluation. *Sustainability*, 6 (9): 5839-5852. doi: 10.3390/su6095839.
- Buratti, C., Moretti, E. & Belloni, E. (2016). Aerogel Plasters for Building Energy Efficiency. I: Pacheco Torgal, F., Buratti, C., Kalaiselvam, S., Granqvist, C.-G. & Ivanov, V. (red.) *Nano and Biotech Based Materials for Energy Building Efficiency*, s. 17-40. Cham: Springer International Publishing.
- Fedoryshyn, N. (2017). *Produksjon og forbruk av energi, energibalanse*. Tilgjengelig fra: <https://www.ssb.no/energi-og-industri/statistikker/energibalanse/aar-forelopige> (lest 19.11.17).
- Fokaides, P. A. & Kalogirou, S. A. (2011). Application of infrared thermography for the determination of the overall heat transfer coefficient (U-Value) in building envelopes. *Applied Energy*, 88 (12): 4358-4365. doi: 10.1016/j.apenergy.2011.05.014.
- Gaspar, K., Casals, M. & Gangolells, M. (2016). A comparison of standardized calculation methods for in situ measurements of facades U-value. *Energy and Buildings*, 130: 592-599. doi: 10.1016/j.enbuild.2016.08.072.
- Gloria Gomes, M., Flores-Colen, I., Manga, L. M., Soares, A. & de Brito, J. (2017). The influence of moisture content on the thermal conductivity of external thermal mortars. *Construction and Building Materials*, 135: 279-286. doi: 10.1016/j.conbuildmat.2016.12.166.
- Gåsbak, J. H., Annika; Kalbakk, Thale Eng; Svensson Anna;. (2012). *Energieffektivisering i eksisterende bygninger SINTEF*.
- Li, F. G. N., Smith, A. Z. P., Biddulph, P., Hamilton, I. G., Lowe, R., Mavrogianni, A., Oikonomou, E., Raslan, R., Stamp, S., Stone, A.,

- et al. (2015). Solid-wall U-values: heat flux measurements compared with standard assumptions. *Building Research and Information*, 43 (2): 238-252. doi: 10.1080/09613218.2014.967977.
- Meld. St. 25 (2015-2016). *Kraft til endring — Energipolitikken mot 2030*: Ministry of Petroleum and Energy. Tilgjengelig fra: <https://www.regjeringen.no/no/dokumenter/meld.-st.-25-20152016/id2482952/> (lest 03.03.2018).
- Miljøverndepartementet. (2011). Mer kunnskap om energieffektivisering i eksisterende bygningsmasse. Oslo: Miljøverndepartementet.
- Sassine, E. (2016). A practical method for in-situ thermal characterization of walls. *Case Studies in Thermal Engineering*, 8: 84-93. doi: 10.1016/j.csite.2016.03.006.
- Schmidt, M. & Schwertfeger, F. (1998). Applications for silica aerogel products. *Journal of Non-Crystalline Solids*, 225 (Supplement C): 364-368. doi: [https://doi.org/10.1016/S0022-3093\(98\)00054-4](https://doi.org/10.1016/S0022-3093(98)00054-4).
- Stahl, T., Ghazi Wakili, K., Hartmeier, S., Franov, E., Niederberger, W. & Zimmermann, M. (2017). Temperature and moisture evolution beneath an aerogel based rendering applied to a historic building. *Journal of Building Engineering*, 12 (Supplement C): 140-146. doi: <https://doi.org/10.1016/j.jobbe.2017.05.016>.
- Thresher, W. C. & Yarbrough, D. W. (2014). Development and Use of an Apparatus for In Situ Evaluation of the Thermal Performance of Building-Envelope Components. I: Stovall, T. K. & Whitaker, T. (red.) American Society for Testing and Materials Special Technical Publications, b. 1574 *Next-Generation Thermal Insulation Challenges and Opportunities*, s. 53-65.
- Wakili, K. G., Stahl, T., Heiduk, E., Schuss, M., Vonbank, R., Pont, U., Sustr, C., Wolosiuk, D. & Mahdavi, A. (2015). High Performance Aerogel Containing Plaster for Historic Buildings with Structured Façades. *Energy Procedia*, 78 (Supplement C): 949-954. doi: <https://doi.org/10.1016/j.egypro.2015.11.027>.

- Walker, R. & Pavia, S. (2015). Thermal performance of a selection of insulation materials suitable for historic buildings. *Building and Environment*, 94: 155-165. doi: 10.1016/j.buildenv.2015.07.033.
- Zagorskis, J., Zavadskas, E. K., Turskis, Z., Burinskiene, M., Blumberga, A. & Blumberga, D. (2014). Thermal insulation alternatives of historic brick buildings in Baltic Sea Region. *Energy and Buildings*, 78: 35-42. doi: 10.1016/j.enbuild.2014.04.010.